

**How to comply
with your environmental permit for
intensive farming**

Appendices 1 – 6

Version 2

January 2010

Published by:

Environment Agency
Rio House
Waterside Drive, Aztec West
Almondsbury, Bristol BS32 4UD
Tel: 0870 8506506
Email: enquiries@environment-agency.gov.uk
www.environment-agency.gov.uk

© Environment Agency
GEHO0110BRSC-E-E

First published 2000
This version January 2010

All rights reserved. This document may be reproduced with prior permission of the Environment Agency.

This is an uncontrolled document. To ensure you are using the latest version please check on the Environment Agency website www.environment-agency.gov.uk

Record of changes:**Standard Farming Installation Rules and Guidance**

Version	Date	Change
1	1 August 2000	Initial version for use available on the website only, little changed from consultation version
2	24 November 2000	Revisions take into account the consultation comments and also restyling for publication
3	30 June 2001	Changed following comments received from industry
4	20 June 2005	Changed following comments from industry, experience from application, and to take account of Intensive Livestock BREF publication

Intensive Farming – How to comply

Version	Date	Change
1	April 2006	Fixed Permit Conditions used as conditions where possible with rules and guidance from version 4 of the Standard Farming Installation Rules. Additional guidance added for existing installations.
2	January 2010	Incorporating changes for the purposes of the Environmental Permitting Regulations

Contents

Appendix 1	Protocol for sampling slurry and solid manure for analysis	4
Appendix 2	Minimising emissions from new pig housing - examples of housing designs from the BREF	6
Appendix 3	Minimising emissions from new poultry housing - examples of housing designs from the BREF	18
Appendix 4	Odour management at intensive livestock installations	33
Appendix 5	Noise management at intensive livestock installations	46
Appendix 6	How to produce a manure management plan	53

Appendix 1 Protocol for sampling slurry and solid manure for analysis¹

A1.1 Why correct sampling matters

The nutrient content of slurry can vary considerably within a store due to settlement and crusting. Similarly, the composition of solid manure in a heap can vary depending on the amount of bedding and losses of nutrients during storage.

If stored materials are to be analysed either in a laboratory or by a rapid on-farm method, it is important that the sample taken represents an 'average' of what is found in the store or heap.

A1.2 General principles of sampling

It is important, where this is practical and safe, to take a number of samples. Take these from a range of positions within the store or heap, bulk them together, mix them and then take a representative sub-sample.

The final sample can be sent to the laboratory for analysis or tested with a slurry N meter or slurry hydrometer on-farm depending on whether information is needed to draw up a full Manure Management Plan, or as a check on earlier data once spreading is in progress.

A1.3 Slurries

Take at least five sub-samples of 2 litres, pour into a larger container, stir thoroughly and pour a 2 litre sample immediately into a smaller clean container to provide the sample for analysis.

Above-ground stores

Ideally, slurry should be fully agitated and sub-samples taken from the reception pit. If this is not possible, and provided there is safe access from an operator's platform, the five sub-samples can be taken at a range of positions, using a weighted 2 litre container attached to a rope.

Below-ground pits

It may be possible to obtain sub-samples at various positions using a weighted container as above, but never enter the pit, as lethal gases may be present. Do not attempt to take samples during or soon after slurry agitation as large amounts of lethal gases may be released from the stirred slurry.

Earth-banked lagoons

If the slurry has been well agitated, sub-samples can be obtained from the tanker or irrigator as outlined below. Do not attempt to sample direct from the lagoon unless there is a secure operator's platform that provides safe access.

Sampling while spreading

If the tanker is fitted with a suitable valve, it may be possible to take five sub-samples from the stationary slurry tanker at intervals while field spreading is in progress. Or, trays placed in the field can be used to collect samples while the material is being spread.

¹ Based on 'Managing Livestock Manures, Booklet 3: Spreading Systems for Slurries and Solid Manures'. MAFF/ADAS/IGER/SRI November 2000.

A1.4 Solid manures

Take at least ten sub-samples of about 1kg each, taken as described below, and place on a clean, dry tray or sheet. Break up any lumps and thoroughly mix the sample. Then take a representative sample of around 2kg for analysis (you should check the weight required with the laboratory).

Manure Heaps

Provided the manure is dry and safe to walk on, identify at least ten locations which appear to be representative of the heap. Having cleared away any weathered material with a spade or fork, dig a hole approx. 0.5m deep and take a 1kg sample from each point. Alternatively, take sub-samples from the face of the heap at various stages during spreading.

Weeping-wall stores

Do not attempt to take samples before the store is emptied as it is not safe to walk on the surface of the stored material. Sub-samples may be taken from the face of the heap once emptying has commenced.

Sampling during spreading

Trays placed in the field can be used to collect samples while the material is being spread. Take care to avoid the possibility of injury from stones and other objects which may be flung out by the spreading mechanism.

A1.5 Storage and analysis

If you analyse slurry using an on-farm rapid method, do this immediately after sampling, making sure that the sample taken is well mixed.

If you send samples to a laboratory for analysis slurry should be dispatched in clean screw-topped 2 litre plastic containers. Leave at least 5cm of airspace to allow the sample to be shaken in the laboratory. For manures, use 500-gauge polythene bags and expel excess air from the bag before sealing.

Clearly label the samples on the outside of the container or bag and dispatch them immediately or within a maximum of seven days if kept in a refrigerator.

Appendix 2 Minimising emissions from new pig housing - examples of housing designs from the BREF

The following examples of housing designs are taken from the Reference Document on Best Available Techniques (BAT) for Intensive Rearing of Poultry and Pigs, commonly referred to as the BREF, published in July 2003 by the European IPPC Bureau. The BREF is currently being reviewed and will be republished. These sections are reproduced here so that you do not need to obtain and read the BREF which is 341 pages long. If required, the full document can be downloaded at <http://eippcb.jrc.es/pages/FActivities.htm>. As this text is taken from a European document all costs are stated in Euros.

This appendix will be updated as further information becomes available on these housing designs and as new techniques and designs are evaluated and considered to be BAT.

The key principles of BAT for reducing air emissions from pig housing are:

- reducing emitting manure surfaces;
- removing the manure (slurry) from the pit to an external slurry store;
- cooling the manure surface;
- using surfaces (for example, of slats and manure channels) which are smooth and easy to clean.

The following examples are divided into sections for sows, farrowing sows including piglets, weaners and growers/finishers. Each section is then sub-divided into the housing designs referred to in the appropriate measures with the relevant BREF section reference included in the sub-section heading.

A2.1 Sows

A2.1.1 Partly-slatted floor with a reduced area manure pit (BREF 4.6.1.4)

Description: Ammonia emissions can be reduced by reducing the manure surface area, in particular by applying a small manure pit with a maximum width of 0.60m. The manure pit is equipped with triangular iron slats or concrete slats. The sows are individually housed.

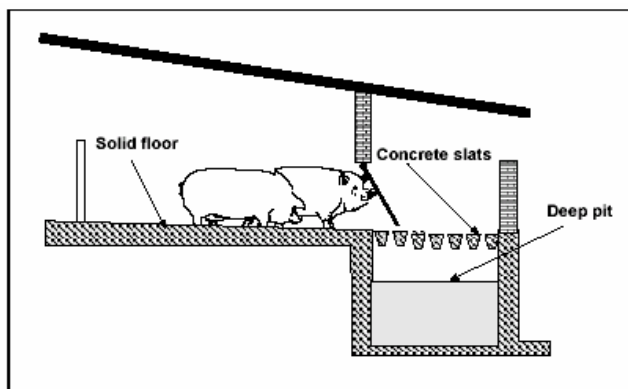

Solid concrete floor and fully-slatted external alley with storage pit underneath

In Italy a loose-housing design is applied with a fully-slatted external alley with the slurry pit underneath; the slurry not being removed very frequently. Indoors, the animals are kept on a solid concrete floor, a hatched opening giving access to the external alley. This design can not be compared with the systems for loose-housed sows with the partly-slatted floors inside the housing. The applied reduction techniques show similar environmental performances and operating conditions, but may differ slightly in costs.

Achieved environmental benefits: The combination of the reduction of the manure pit and slurry surface and the fast discharge of manure by using triangular slats reduce NH₃-emissions by 20 to 40 %. In a system, individual housing and group housing show different emissions due to the differences in manure emitting surface per sow. With loose housing of sows, levels are reported to be 2.96 kg NH₃ per sow place per year (Italy). For the individual housing of sows levels of 1.23 (Denmark) and 2.40 (Netherlands) NH₃ per sow place per year respectively have been reported.

Cross-media effects: These houses can be naturally or mechanically ventilated. In Denmark mechanical ventilation is applied and dimensioned for an output of a maximum of 100 m³ per hour per sow place. In areas with low outdoor temperatures these units can also be equipped with auxiliary heating. Energy input is unchanged. In the case of the external slurry pit, a reduced emission will not benefit the internal environment, which can be considered as one of the advantages of the reduced pit inside. In Italy energy savings are possible because artificial ventilation is not required.

Operational data: The slurry is usually removed via a central sewer system by opening a valve and using inclination of the manure pipe. Some systems are equipped with scrapers.

Applicability: In existing houses, the applicability depends on the design of the existing manure pit, but it is mostly difficult, if not impossible, to apply. For existing housings with an internal concrete solid floor an extension with an external alley with a storage pit might be possible. The application of a maximum width of 0.60 m may require more pit depth or more frequent removal and then outside manure storage. If a minimum pit size is imposed then by relation, a reduction will not be applicable, (e.g. Ireland: > 0.90 m). In some European countries (e.g. DK) the individual housing of sows will decline because of changing legislation stipulating loose-housing systems.

Costs: The remaining ammonia emission compared with a fully-slatted floor depends on the reference. With a 40 % reduction (4.2 to 2.4 kg NH₃), the additional investment is about EUR 17.75 per sow place or EUR 9.85 per kg NH₃ abated. Additional annual operating costs are EUR 5.80 per sow place or EUR 3.25 per kg NH₃. With a 20 % reduction, an additional investment of EUR 1.76 per sow place was reported. The system with the external manure pit and slatted floor reportedly had an additional investment of EUR 8.92 per sow place per year.

Reference farms: This is a very common housing system for mating and gestating sows in many European Member States. In Italy 40 % of the growers/finishers are kept in these kind of installations.

A2.1.2 A fully-slatted floor with vacuum system for frequent slurry removal (BREF 4.6.1.1)

Description: On the bottom of the pit under a fully-slatted or part-slatted floor, outlets are placed every 10 m² and that are connected to a sewerage system. Slurry is discharged by opening a valve in the main slurry pipe. A slight vacuum develops and allows the slurry removal. The pit can be emptied once or twice a week, depending on the capacity of the pit itself.

Achieved environmental benefits: Reduction of NH₃-emission by about 25% due to frequent removal of slurry. Italian data reported about 2.77 kg NH₃ per sow place per year.

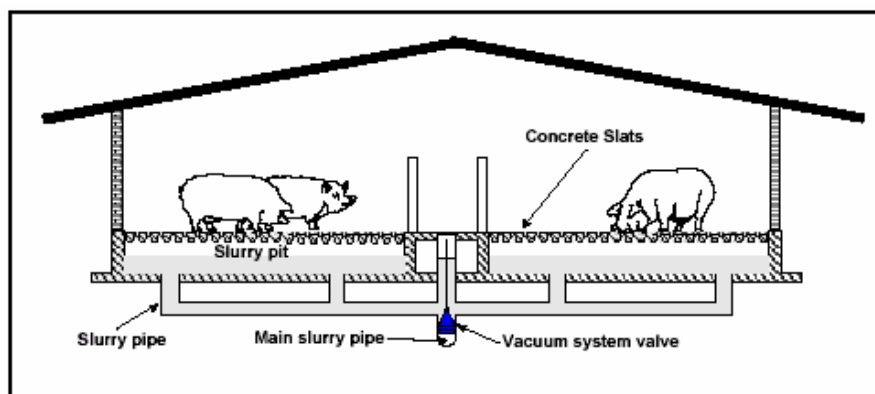

Fully-slatted floor with vacuum system

Cross-media effects: As the system is manually operated, no additional energy is required. Less water is needed to clean the floor compared to partly-slatted or solid concrete floors. It is suggested that any aerosols which develop during the discharge of the slurry are removed by the vacuum created when opening the valves.

Operational data: This technique is easy to operate compared to the reference technique.

Applicability: In existing houses, this technique may be applicable with:

- solid concrete floors and with sufficient height to build on top of the existing floor
- renovation of a FSF with a storage pit underneath.

Costs: Italy reported a negative extra cost (i.e. a benefit) of EUR 8.60 per sow place per year, when applied in new housing, compared to the costs of the reference system.

Reference farms: An increasing number of farms in Italy are adopting this technique in new housing for gestating sows, e.g. Sartori farm, Parma.

A2.1.3 A partly-slatted floor with vacuum system for frequent slurry removal (BREF 4.6.1.6)

Description: cross-media effects: See A2.1.2.

Achieved environmental benefits: With a partially slatted floor and a vacuum system the NH₃-emission is reduced to 2.77 kg NH₃ per sow place per year on concrete slats, and to 2.40 kg NH₃ per sow place per year on metal slats for loose housed sows. This compares with the reference as relative reductions of 25 % and 35 % respectively.

Operational data: This technique is easy to operate compared to the reference technique.

Applicability: In existing housing application, its applicability is limited to housing with partially slatted floors and a storage pit with sufficient depth.

Costs: There are no data available on capital costs, but the annual operational costs are thought to be the same as for growers/finishers and this is an estimated negative extra cost (i.e. a benefit) of EUR 4 when concrete slats are applied and EUR 1.50 (also a benefit) when metal slats are applied in a new housing.

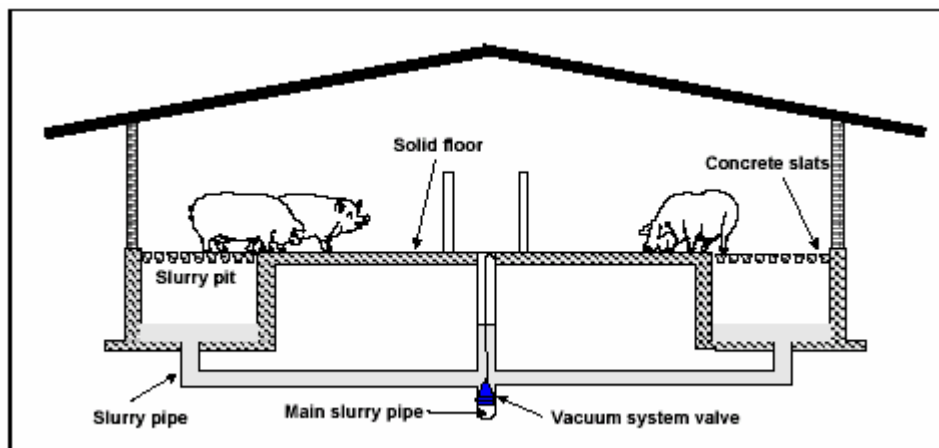

Partly-slatted floor with vacuum system

A2.2 Farrowing sows including piglets

A2.2.1 Farrowing pen with part or fully-slatted iron or plastic floor with a combination of water and manure channel (BREF 4.6.2.2)

Description: The sow has a fixed place and as a result it is clear where the dunging area will be. The manure pit is split up into a wide water channel at the front and a small manure channel at the back. This greatly reduces the manure surface, which in turn reduces the ammonia emission. The front channel is partly filled with water. The slats are made of iron or plastic.

Achieved environmental benefits: It limits the manure surface and has frequent removal of the slurry by a sewerage system. A reduction of 52 % (4.0 kg NH₃ per sow place per year (NL, B)) can be achieved.

Cross-media effects: The frequent removal of the slurry may require extra energy. Water is needed to fill the front pit.

Applicability: This system is easy to implement in the reconstructions of existing buildings with the reference technique, as the design of the pen is not critical for the applicability of the system. Very simply, all that would be needed would be separation of the two pits.

Operational data: Supposedly the two pits are emptied into the same slurry sewerage system towards the slurry store. Water is changed after each round (approximately 4 weeks). The front section is drained completely, cleaned, disinfected and then filled up again with fresh water.

Costs: The extra investment costs are EUR 60 per pig place. This means for a 52 % reduction about EUR 13.85 per kg NH₃ abated. The extra annual operational costs are EUR 1.00 per pig place or EUR 0.25 per kg NH₃.

Reference farms: In the Netherlands 5000 sow places are equipped with this system.

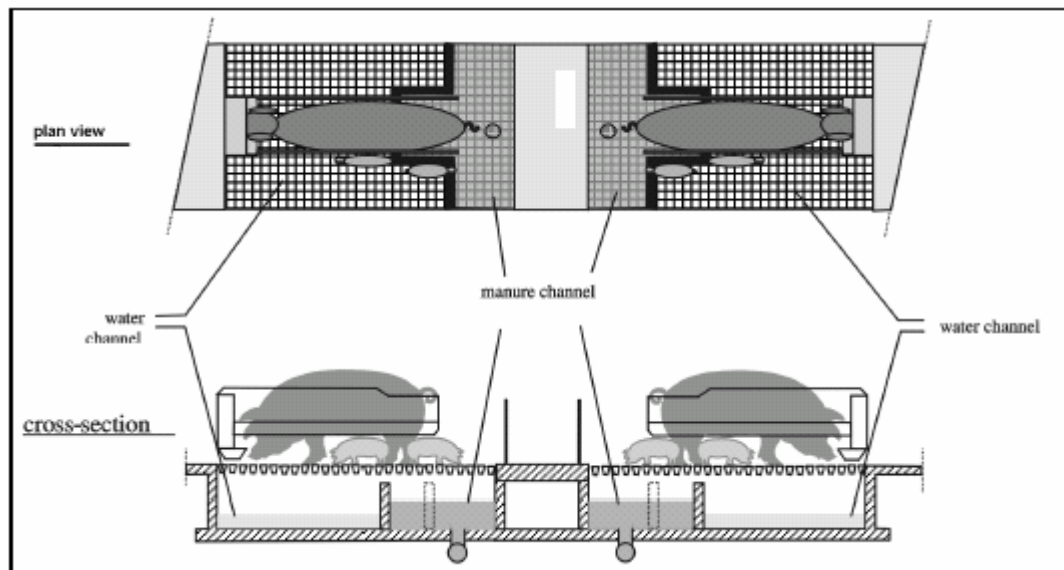

Combination of a water and manure channel

A2.2.2 Farrowing pen with part or fully-slatted iron or plastic floor with a flushing system with manure gutters (BREF 4.6.2.3)

Description: Small gutters limit the manure surface. This reduces the ammonia emission. Application is possible in pens with a partly or fully-slatted floor. The manure is removed frequently by a flushing system. The slats are made of triangular iron slats. The gutter sides should have a slope of 60 degrees. The gutters should be flushed twice a day.

Environmental benefit: Limiting the manure surface in the manure channel, in combination with fast discharging of the manure from the slatted area by using plastic or iron triangular bars, and removing the manure twice a day by flushing reduces NH₃ emissions by 60 % (3.3 kg NH₃ per sow place per year (NL, B))

Cross-media effects: This system has an extra energy consumption of 8.5 kWh per sow place per year, related to the flushing of the gutters. Odour peaks due to flushing may cause a nuisance when receptors are living near the farm. On a case by case basis it has to be decided whether an overall load (thus applying a no-flushing system) or peak values are more important.

Applicability: In existing houses the applicability depends on the design of the existing manure pit, but it does not seem difficult with the reference system.

Costs: The extra investment costs are EUR 535 per sow place. This means with a 60 % reduction, i.e. 8.3 to 3.3 kg NH₃, costs are EUR 107 per kg NH₃ abated. The extra operational costs per year are EUR 86.00 per pig place. This means EUR 17.20 per kg NH₃. To achieve a slightly better reduction extra costs are considerably higher than those reported for the system with a separated water and manure channel. This difference could not be explained from the submitted information.

Reference farms: In the Netherlands, about 500 farrowing sow places are equipped with this system.

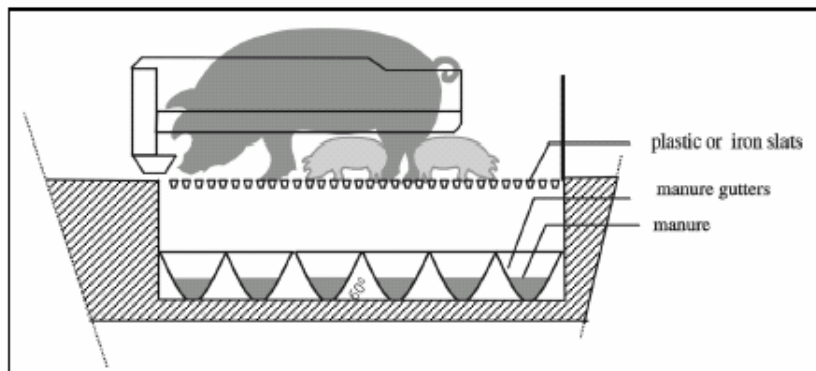

Flushing system with manure gutters

A2.2.3 Farrowing pen with part or fully-slatted iron or plastic floor with a manure pan underneath (BREF 4.6.2.4)

Description: A prefabricated pan is placed under the slatted floor and can be adapted to the dimensions of the pen. The pan is deepest at one end of the pen and the pan has a slope of at least 3° towards a central slurry channel. The pan is connected with a sewerage system. Every three days the manure should be removed by the sewerage system. The application does not depend on the pen design, or on whether it is with a fully or a partly-slatted floor. The slats are made of iron or plastic.

Environmental benefit: Limiting the manure surface and frequent removal of the slurry by a sewerage system achieves a 65 % reduction of NH₃-emissions (2.9 kg NH₃ per sow place per year). An increased reduction of 50 % compared with the sloped board construction is achieved, although both designs seem to be very similar. A lower emitting surface and a more frequent removal of the slurry is considered to be the most important factors determining the difference.

Applicability: This system is easy to implement in reconstructions of existing buildings. The design of the pen is not critical for the applicability of the system.

Costs: The extra investment costs are EUR 280 per pig place. This means with a 65 % reduction, i.e. 8.3 to 2.9 kg NH₃, costs are EUR 53.85 per kg NH₃ abated. The extra operational costs per year are EUR 45.85 per pig place. This means EUR 8.80 per kg NH₃.

Reference farms: In the Netherlands, about 10000 sow places are equipped with this system. This system has only recently been developed (1998). Currently this system is being implemented in many reconstructions as well as in new buildings.

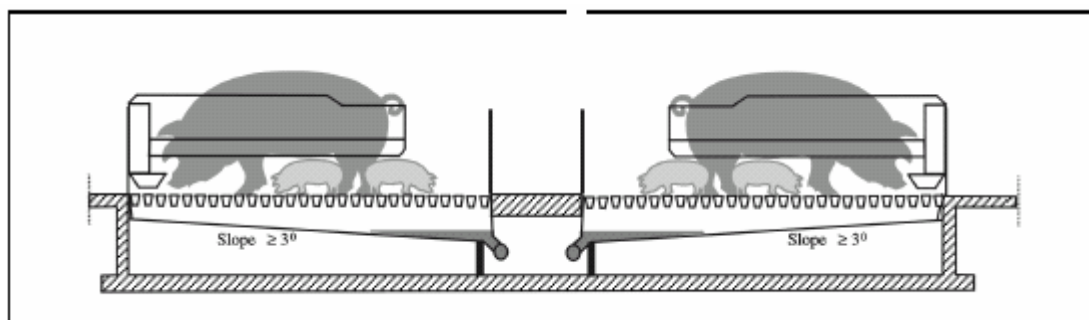

Fully-slatted floor with manure pan

A2.3 Weaners

A2.3.1 Slurry systems with a pen or flatdeck with a fully-slatted (BREF 4.6.1.1) or partly-slatted (BREF 4.6.1.6) floor with a vacuum system for frequent slurry removal

See A2.1.2 and A2.1.3 for details.

A2.3.2 Slurry systems with a pen or flatdeck with a fully-slatted floor beneath which there is a concrete sloped floor to separate faeces or urine (BREF 4.6.3.1)

Description: A board (concrete or other material) with a very smooth surface is placed under the slatted floor. The size can be adapted to the dimensions of the pen. The board has a slope of at least 12° towards a central slurry pit, which is connected with a sewerage system. The slurry is removed weekly to a store by gravity or by pumping. The slats are made of iron or plastic. At the end of the weaning period, dry faeces are easily removed by water jets.

Achieved environmental benefits: Immediate removal of manure to central channel and immediate draining of urine achieves reduction of 30 % (0.42 kg NH₃ per pig place per year (l)).

Cross-media effects: There is no additional energy required.

Applicability: With a manure pit of sufficient depth, this technique can be easily applied in existing housing.

Costs: Investment costs are estimated to be less than the reference, if the benefits are included in costs calculation.

Reference farms: A few applications in Italy.

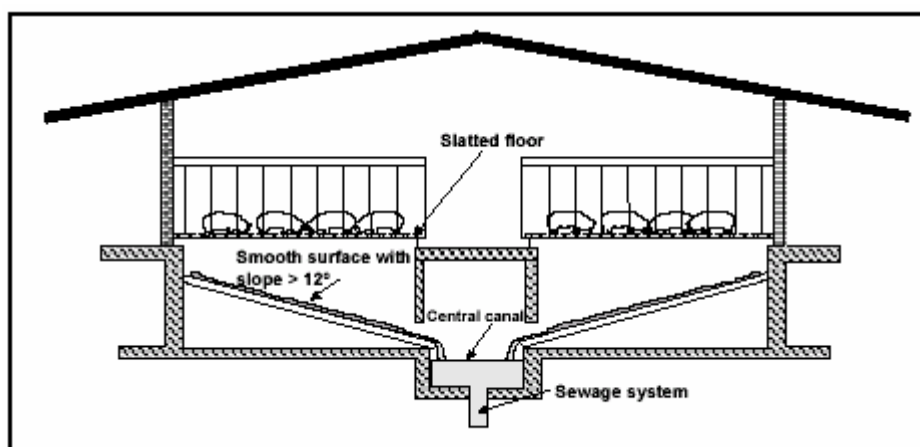

Flatdecks or pens with concrete sloped floor underneath to separate faeces and urine

A2.3.3 Slurry systems with a pen with a partly-slatted floor (two climate system) (BREF 4.6.3.4)

Description: Manure is handled as a slurry. It is often drained through a pipe discharge system where the individual sections of the manure channels are drained via plugs in the discharge pipes. The channels can also be emptied via gates. The channels are drained after the removal of each group of pigs, often in connection with disinfecting the pens, i.e. at intervals of 6 - 8 weeks.

Achieved environmental benefits: A reduction in ammonia emissions by 34 % (0.53 kg NH₃ per pig place per year) is achieved when applying this technique. This technique has been applied in Denmark and its performance is therefore compared with the emission level of the reference obtained in Denmark (0.8 kg NH₃ per pig place per year).

Cross-media effects: The naturally ventilated design uses less energy compared to the reference.

Operational data: This housing type is normally equipped with mechanical ventilation, either in the form of negative-pressure or balanced-pressure ventilation. The ventilation is dimensioned for a maximum output of 40 m³ per hour per place. Auxiliary heating is available in the form of either electric fan heaters or a central heating plant with heating pipes. Naturally ventilated designs are also applied.

Applicability: This system is applicable in new and existing installations.

Costs: The extra investment costs and operational costs are estimated to be equal to the reference system.

Reference farms: It is estimated that in Denmark 30 – 40 percent of the weaners, corresponding to about 1600000 places, are housed on partly-slatted floors weighing from 7.5 to 30 kg. This figure is expected to increase.

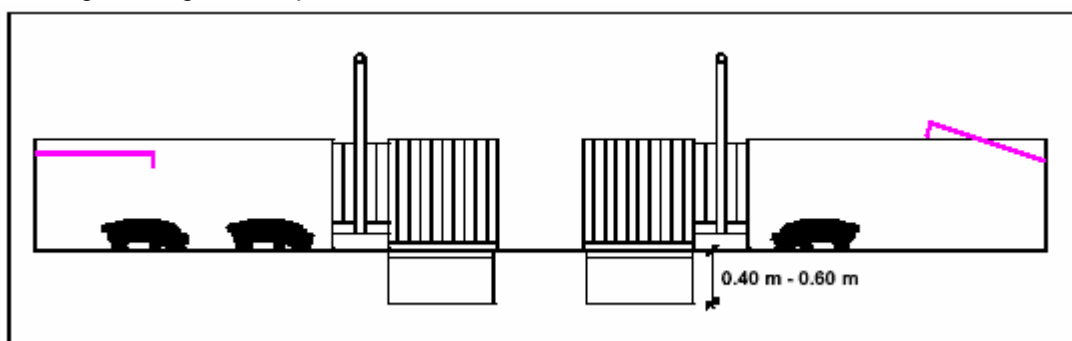

Cross-section of rearing unit with partly-slatted floor, two climate

A2.3.4 Slurry systems with a pen with a partly-slatted iron or plastic floor and a sloped or convex solid floor (BREF 4.6.3.5)

Description: Using a partly solid concrete floor reduces the manure surface which reduces the ammonia emission. Application is possible in pens with a convex floor. The convex floor separates the two channels. Application is also possible in pens with a partly-slatted floor consisting of a solid concrete floor on a slope in front of the pen. The slats can be iron or plastic (not concrete slats).

Achieved environmental benefits: Limiting the manure surface in the manure channel achieves a reduction of 43 % (0.34 kg NH₃ per pig place per year). The reduction can in fact only be achieved by changing the design of the pen. This design is similar to the previous design, although a higher reduction is achieved, which is attributed to the convex or sloped floor.

Operational data: It is assumed that this is similar to the reference system.

Applicability: The system with partly-slatted floor or a convex floor can be applied in new houses. In existing houses the applicability depends on the design of the existing manure pit.

Costs: Extra investment is not needed if this alternative could be applied instead of a fully-slatted floor. Annual costs are also similar.

Reference farms: At least 10000 piglet places have been equipped with this system in the Netherlands.

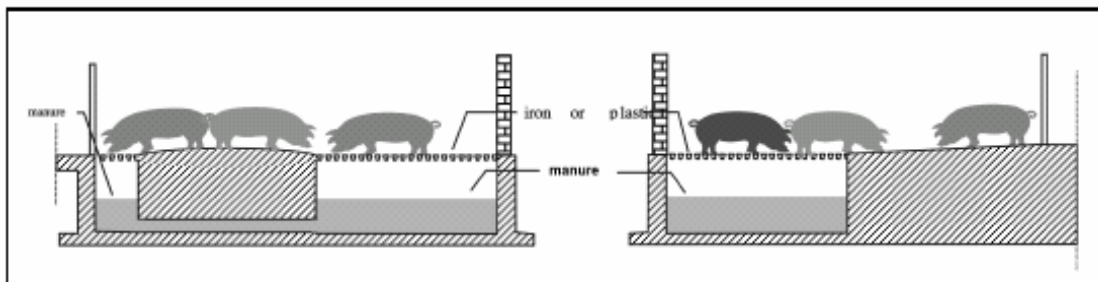

Partly-slatted floor with iron or plastic slats and convex or sloped concrete floor

A2.3.5 Slurry systems with a pen with a partly-slatted metal or plastic floor and a shallow manure pit and channel for spoiled drinking water (BREF 4.6.3.6)

Description: Using a partly solid concrete floor reduces the manure surface which reduces the ammonia emission. Application is possible in pens with a convex floor. The convex floor separates the two channels. The front channel is partly filled with water, as the pigs don't normally use the front area as a dunging area. Only spoiled feed concentrates come into the front channel. The main function of the water is to prevent flies breeding.

Achieved environmental benefits: Limiting the manure surface in the manure channel, together with quickly discharging the manure on the slatted area by using iron triangular bars and removing the manure frequently by a sewerage system reduces emissions by 57 % (0.26 kg NH₃ per pig place per year (NL, B)).

Cross-media effects: No extra energy required.

Operational data: It is assumed to be similar to the reference system.

Applicability: In existing houses the applicability depends on the design of the existing manure pit.

Costs: The extra investment is EUR 2.85 per pig place. The extra annual operational costs are EUR 0.35 per pig place.

Reference farms: In the Netherlands, about 250000 weaner places have been equipped with this system.

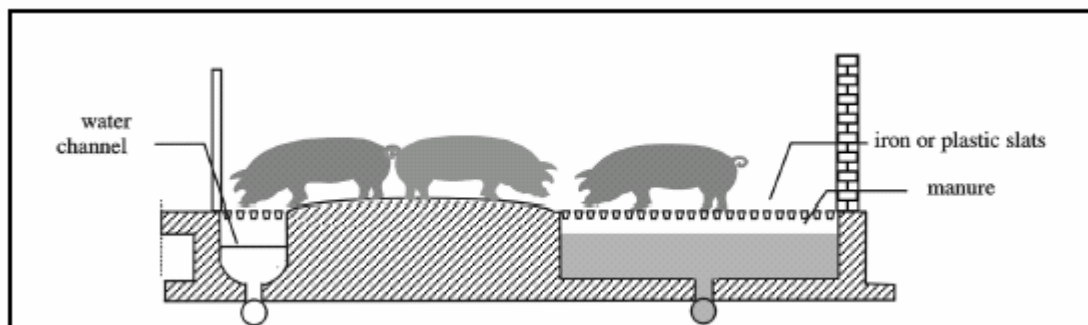

Shallow manure pit with a channel for spoiled drinking water in front in combination with a convex floor with iron or plastic slats

A2.3.6 Slurry systems with a pen with a partly-slatted floor with triangular iron slats and a manure channel with sloped side walls (BREF 4.6.3.9)

Description: Side wall(s) on a slope reduce the manure surface which reduces the ammonia emission. Application is possible in pens with a convex floor. The convex floor separates the two channels. The front channel is partly filled with water, as the pigs do not normally use the front area as a dunging area. Only spoiled feed concentrates come into the front channel. The main function of the water is to prevent flies breeding. Application is also possible in pens with a partly-slatted floor consisting of a solid concrete floor on a slope in front of the pen. The manure will be removed frequently by a sewerage system. The slats are made of triangular iron bars. The manure surface in the manure channel should not be larger than 0.07 m² per pig place. The surface of the sloping wall(s) should be made of a smooth material to prevent the manure adhering to the surface. A sloping wall at the back is not required, but when a sloping wall is present, then this wall should have a slope between 60 and 90 degrees. The wall next to the solid concrete floor should have a slope of between 45 and 90 degrees.

Achieved environmental benefits: Limiting the manure surface in the manure channel, together with a fast discharge of the manure from the slatted area by using iron triangular bars and a frequent removal of the manure by means of a sewerage system achieves a 72 % reduction (0.17 kg NH₃ per pig place per year).

Cross-media effects: This system does not need extra energy compared with the reference.

Operational data: This is similar to the reference system.

Applicability: The system with side wall(s) on a slope can be applied in existing houses, with only a few alterations.

Costs: Extra investment costs are EUR 4.55 per pig place. With a 72 % reduction, this means about EUR 10.58 per kg NH₃ abated. Extra annual operational costs are EUR 0.75 per pig place or EUR 1.74 per kg NH₃.

Reference farms: This system is a recent development (1998). Currently this system is being implemented in most new buildings and alterations in the Netherlands.

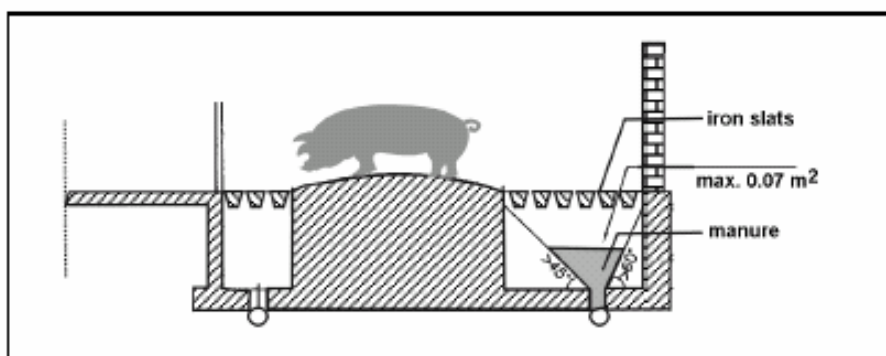

Convex floor with triangular iron slats in combination with sewerage system and side walls on a slope in the manure channel

A2.4 Growers/Finishers

A2.4.1 Slurry systems with a fully-slatted floor with vacuum system for frequent removal (BREF 4.6.1.1)

See A2.1.2 for details.

A2.4.2 Slurry systems with a partly-slatted floor with a reduced manure pit, including slanted walls and a vacuum system (BREF 4.6.4.3)

Description: See A2.4.3 below where the system applying slanted walls is described and A2.1.2 above where the vacuum system is described. Combining the positive effects of these two techniques results in the PSF with a reduced manure pit, including slanted walls and a vacuum system.

Achieved environmental benefits: Due to limiting the manure surface in the manure channel and removing manure frequently by a vacuum system, it is estimated that the emission could be reduced by at least 60 % with concrete slats and by 66 % in the case of triangular iron slats.

Cross-media effects: As the system is manually operated, no additional energy is required. It is suggested that the vacuum created when opening the valves removes aerosols developing during discharge of the slurry.

Operational data: Similar to the reference system.

Applicability: The system with slanted side wall(s) can be applied in new houses. In existing houses the applicability depends on the dimensions of the existing manure pit. To implement this system only a few alterations are needed and hardly any change in management technique or regime are needed. The manure surface should be a maximum of 0.18 m² per pig place.

Costs: The extra investment costs are EUR 3.00 per pig place. The extra operational costs per year are EUR 0.50 per pig place. The additional vacuum system might require some extra costs. For the iron bars, cost data are slightly different. The extra annual investment costs are EUR 23 per pig place.

Reference farms: This combination of techniques has not been applied yet.

A2.4.3 Slurry systems with a partly-slatted floor with a central convex solid floor at the front of the pen, a manure gutter with slanted sidewalls and sloped manure pit (BREF 4.6.4.2)

Description: Side wall(s) on a slope reduce the manure surface. This reduces ammonia emissions. Application is possible in pens with a convex floor. The convex floor separates the two channels. The front channel is partly filled with water, as the pigs do not normally use the front area as a dunging area. Only spoiled feed concentrates come into the front channel. The main function of the water is mainly to prevent flies breeding. Application is also possible in pens with a partly-slatted concrete floor consisting of a solid concrete floor on a slope in front of the pen. The manure will be removed frequently by a sewerage system. The manure channel has a width of at least 1.10 metre. The manure surface in the manure channel should not be larger than 0.18 m² per pig place. The surface of the sloping wall(s) should be made of a smooth material to the manure adhering to the surface. A sloping wall at the back is not required, but when a sloping wall is present, then this wall should have a slope of between 60 and 90 degrees. The wall next to the solid concrete floor should have a slope of between 45 and 90 degrees. The slats are made of concrete.

Achieved environmental benefits: Limiting the manure surface in the manure channel and removing manure frequently by a sewerage system reduces the emission by 60 % (1.2 kg NH₃ per pig place per year) with concrete slats and by 66 % (1.0 kg NH₃ per pig place per year) in the case of triangular iron bar slats.

Cross-media effects: This system does not require any extra energy.

Operational data: Similar to the reference system.

Applicability: The system with slanted side wall(s) can be applied in new houses. In existing houses the applicability depends on the dimensions of the existing manure pit. To implement this system only a few alterations are needed and hardly any change in management technique or regime are needed. The manure surface should be a maximum of 0.18 m² per pig place.

Costs: The extra investment costs are EUR 3.00 per pig place. This means with a 60 % reduction (i.e. 3.0 to 1.2 kg NH₃), costs are about EUR 1.65 per kg NH₃ abated. The extra operational costs per year are EUR 0.50 per pig place. This means EUR 0.28 per kg NH₃ abated. For the iron bars cost data are slightly different. The extra investment costs are EUR 23 per pig place. This means with 65 % reduction about EUR 12 per kg NH₃ abated. The extra annual operational costs are EUR 15 per pig place or EUR 2.70 per kg NH₃ abated.

Reference farms: The system with iron triangular bars was developed in the mid-nineties and has been implemented in many new buildings and alterations in the Netherlands.

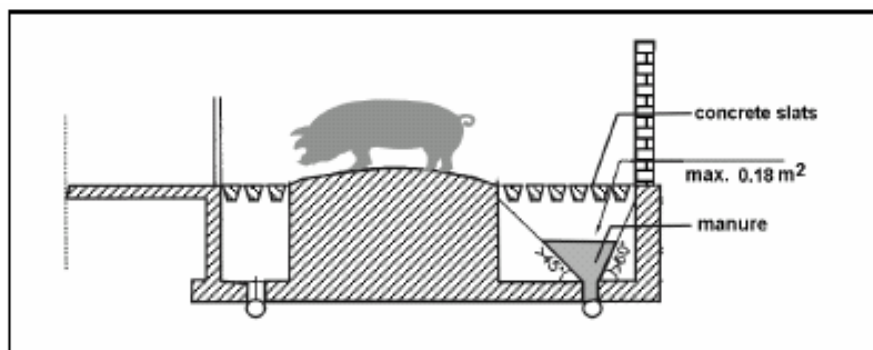

Convex floor with concrete slats and side walls on a slope in the manure pit

Appendix 3 Minimising emissions from new poultry housing - examples of housing designs from the BREF

The following examples of housing designs are taken from the Reference Document on Best Available Techniques (BAT) for Intensive Rearing of Poultry and Pigs, commonly referred to as the BREF, published in July 2003 by the European IPPC Bureau. The BREF is currently being reviewed and will be republished. These sections are reproduced here so that you do not need to obtain and read the BREF which is 341 pages long. If required, the full document can be downloaded at <http://eippcb.jrc.es/pages/FActivities.htm>. As this text is taken from a European document all costs are stated in Euros.

This appendix will be updated as further information becomes available on these housing designs and as new techniques and designs are evaluated and considered to be BAT.

The following examples are divided into sections for laying hens and replacement pullets, broilers and floor reared replacement pullets, turkeys, and ducks. Each section is then subdivided into the housing designs referred to in the appropriate measures with the relevant BREF section reference included in the sub-section heading.

A3.1 Laying hens and replacement pullets

A3.1.1 Caged systems with deep pit with ventilated manure store (BREF 4.5.1.1: deep-pit and canal house)

Description: The cages are positioned above the manure storage pit. The height of a deep-pit system measures between 180 and 250 cm. The canal house has a pit, which measures approximately 100 cm. The wet droppings fall in the pit and remain there for periods of up to a year or more. In a deep-pit house as well as in a canal house, fans that are placed below the cages in the lower part of the building draw in ventilation air. The air is drawn into the building through the roof (open ridge system) and passes the cage area, where it is warmed up. The warm airstreams then pass over the manure stored in the pit and leave the house. The manure that is stored in the pit is dried by this flow of warm air. During storage, heating by fermentation occurs. This fermentation results in a high ammonia emission level. To get a good drying result the manure on the plates underneath the cages should be pre-dried for about 3 days. After 3 days the manure has a dry material content of about 35 – 40 %. In the past in the UK, a slat manure drying technique was applied to deep-pit houses with fully stepped and flatdeck systems. It left manure drying in steep sided cones for 6 months, after which the manure was dropped into the deep pit and the slats reset for the rest of the year. This technique may still be applied, but has largely fallen out of use with the demise of most fully stepped and flatdeck cages in deep-pit systems.

Achieved environmental benefits: An extractor fan pulls air through the housing past the cages and manure heap. Although the manure is dried with air, some anaerobic fermentation can occur that can cause high ammonia emissions. Reported data on the emission at the outlet of the fans vary between 0.154 (estimated in Italy) and 0.386 (measured in the Netherlands) kg NH₃ per laying hen-place per year. The difference is significant but is probably due to the different climatic conditions. This system shows a better performance in Mediterranean climates than in climates with much lower temperatures. A canal house is assumed to have the same emission levels as a deep pit house. Particularly in winter, when the ventilation rate is lower, ammonia concentrations in the bird area may be reduced, but emissions from the manure storage are not. Providing additional aeration of the manure using perforated polyethylene tubes could achieve lower emissions, but no results have been reported.

Cross-media effects: The application of these systems requires energy for the fans, but it must be noted that the fans will serve both the manure storage and the layer housing areas.

Operational data: This housing system results in manure with a dry matter of 50 – 60 %. Because the manure is dried so quickly, there is little odour from the cages. The emission appears at the outlets of the open storage. Usually, manure is stored for a full cycle (13 – 15 months). No separate storage facility is needed. In practice, problems are encountered with canal and deep-pit houses because of the level of ammonia concentrations, which can be so high that it is difficult to work in these areas. Flies and dirty eggs may also cause problems, but good maintenance should be able to control this. In the Netherlands this system is being phased out because of the problems with the ammonia emissions, flies and odour.

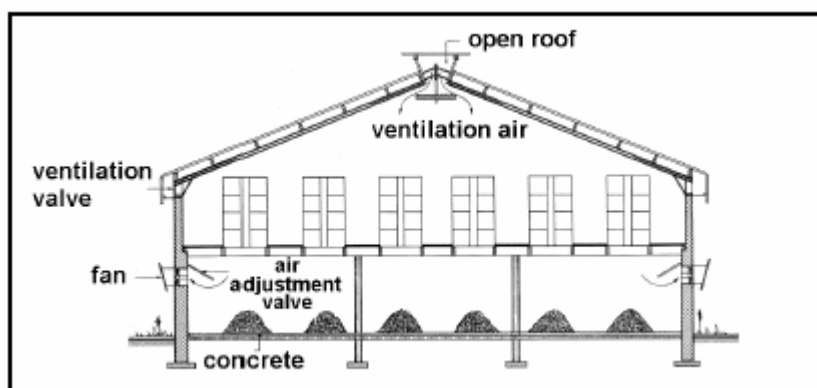

Deep-pit system for laying hens

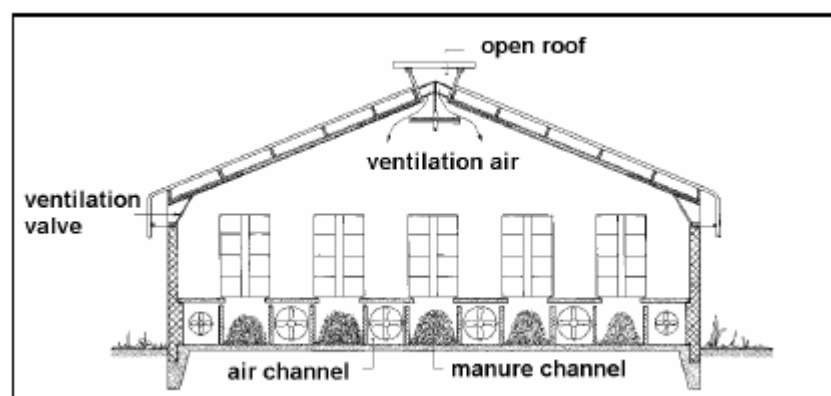

Example of a canal system for laying hens

Applicability: In Italy, this system is applied on large farms, as the labour input required is low. However, the system can only be applied in new houses, since it needs sufficient height for the manure storage, although it is possible that an appropriate existing building, such as an existing two-storey layer house, could possibly be converted into a high-rise house, but no information has been submitted to demonstrate this.

Costs: The extra investment costs of an additional ground floor are reported to be partially offset by the fact that no external storage is necessary. Extra investment costs compared with an open storage system amount to EUR 0.8 per bird place. Extra costs for energy are EUR 0.03/year per bird place. The total extra annual costs are EUR 0.12 per bird place per year. This means that with a reduction from 0.220 to 0.154 kg NH₃ per bird place per year (i.e. 30 %) approximately EUR 1.84 per kg NH₃ is abated.

Reference farms: Deep pit houses are used in several Member States (UK, Netherlands (2.5 million hens) and Italy (8 – 9 million hens)).

A3.1.2 Caged systems with manure removal, at least twice a week, by way of manure belts to covered storage (BREF 4.5.1.4)

Description: The manure-belt battery is commonly applied throughout Europe. In this system the laying hens' manure is collected on manure-belts below the cages and transported to a closed storage at least twice a week. The manure is collected on manure-belts that are situated under each tier (or cage level). At the end of the belt a cross conveyor transports the manure further to the external storage. The manure-belts are made of smooth, easy-to-clean polypropylene or trevira and no residue sticks to these belts. With modern reinforced belts, manure can be removed from very long runs of cages. Some drying takes place on the belts, especially in summer conditions, and manure may be held on the belts for up to a week.

In improved belt systems, air is blown over the manure to achieve faster drying of the manure. The air is introduced just under each tier of cages, usually via rigid polypropylene ducts. Another benefit is the introduction of fresh cooling air immediately adjacent to the birds. Further improvements consist of the introduction of pre-warmed house air and/or the use of heat exchangers to pre-warm incoming outside air.

Having clean belts and effecting frequent manure removal to a closed storage ensures low ammonia emissions from the housing area. A modification to the cage system ensures the removal of manure, through adding extensions on the feed hopper that sweep the droppings onto the belt that runs between the cages. This system needs an additional storage facility.

Achieved environmental benefits: The environmental performance of this system depends on the frequency of manure removal, although it is certainly better than the scraper system, which usually leaves some manure behind. The higher the frequency of removal the lower the emission from the housing, e.g. if manure is removed at least twice a week a reduced emission of 0.035 kg NH₃ per bird place per year is reported. With a removal frequency of twice a day, the ammonia emission is reported to drop to 0.020 kg NH₃ per bird place per year. Because the manure is transported out of the house and there is no manure residue on the manure belts, a lower odour level is obtained, which improves the climate in the house. With this system no manure drying occurs and wet manure leaves the housing to be stored elsewhere or to be immediately applied on land.

Cross-media effects: Application of this system needs additional energy to run the belts. The lowest emission is achieved by both applying the scraping device to the feed hopper and by running the manure belt more frequently. It is assumed that any extra energy required is only due to running the manure belt more frequently.

Operational data: Wet manure is produced instead of dry manure. In the Netherlands this system is being phased out because of the high costs for selling this 'wet' manure and due to the relatively high ammonia emissions.

Applicability: Cages with manure belts can be used in new and existing buildings. They are usually applied with vertical tiered cages. The reference system would need full replacement. It is questionable whether the more frequent removal method can be considered an improvement compared to the more sophisticated systems available.

Costs: The extra investment costs of operating a twice-weekly removal compared with the open storage system are EUR 1.14 per bird place. The hopper construction required for a more frequent removal would require extra costs. These costs have not been reported. With a 58 % reduction of the emission (compared with the reference system) the relative costs are about EUR 23.6 per kg NH₃ abated. The extra operating costs per laying hen per year are

EUR 0.17.

Reference farms: In the Netherlands about 3.524 million hens are kept in these systems. This system is only occasionally installed in a new building. Data on the application of the system with the feed hopper construction have not been submitted.

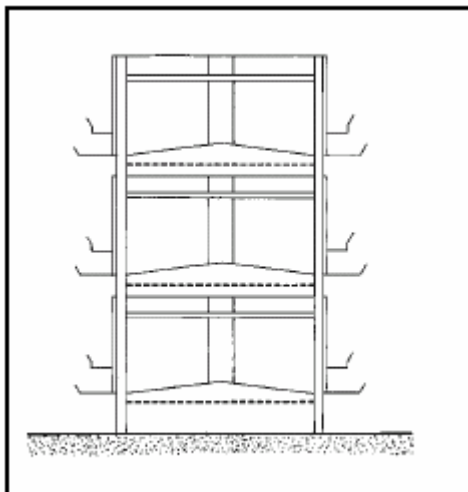

Example of a manure-belt battery (3 tiers) with a belt under each tier to remove manure to a closed storage

A3.1.3 Vertical tiered cages with manure belt with forced air drying, where the manure is removed at least once a week to covered storage (BREF 4.5.1.5.1)

Description: The manure from the laying hens is collected on a manure belt, of which there is one for each tier. Over the belt a perforated tube is placed which blows air (which may be preheated) over the manure on the belt. The manure is removed from the house once a week to a covered storage outside the house, where the manure can be stored for longer. On some farms, manure is put into a container and removed from the farm within two weeks.

Achieved environmental benefits: When a forced drying system is installed with a drying capacity of 0.4 m³ of air per laying hen per hour, then over a drying period of 7 days a dry matter content of the manure of at least 45 % is achieved. The NH₃ emission is 0.035 kg NH₃ per laying hen-place per year. No manure is left on the belts after removal.

Cross-media effects: Energy is required for operating the belts and the fans used to blow the air over the manure. Additional energy input is also required if preheating is applied. In modern cage houses, preheating is achieved by the application of a heat exchanger, in which outside air is drawn in and warmed up by the ventilation air that is emitted from the house. The level of extra energy input will vary; reported data show an extra 1.0 – 1.6 kWh per hen place per year used compared with the reference system, leading to a total energy use of 2 to 3 kWh per layer bird place per year.

Operational data: With this system it is possible to get a very low NH₃ emission and to reduce odour in the house. The preheated air dries the manure, but an additional benefit is that the climate in the cages close to the animals is very good. This allows better production results to be achieved than with the reference system.

Applicability: This system can be applied in new and existing buildings with 3 tiers or more. The aeration installation could possibly even be added to an existing belt cage system which does not have drying equipment, but no practical example has been submitted.

Costs: The cost when compared with the reference system, must take into account that external manure storage may be simpler (no slurry, but dry manure) and that in vertical tiered cages more birds can be housed. Depending on inclusion of these cost factors, the extra investment costs vary and are reported to be between EUR 0.39 (I) and EUR 2.05 (NL) per bird place per year. Additional energy costs will vary, as will the annual costs. Annual costs have been reported of EUR 0.193 (I) and EUR 0.57 (NL) per bird place per year. Cost efficiencies vary widely. For a 60 % reduction compared with the reference system, its application in Italy would cost EUR 1.45 per kg NH₃ abated, whereas in the Netherlands it would cost EUR 42.70 per kg NH₃ abated.

Reference farms: In the Netherlands 14.598 million hens are kept in this system. The system with the NH₃ emission of 0.035 kg per laying hen per year was developed about 12 years ago. Nowadays, this system is implemented in most new buildings and reconstructions.

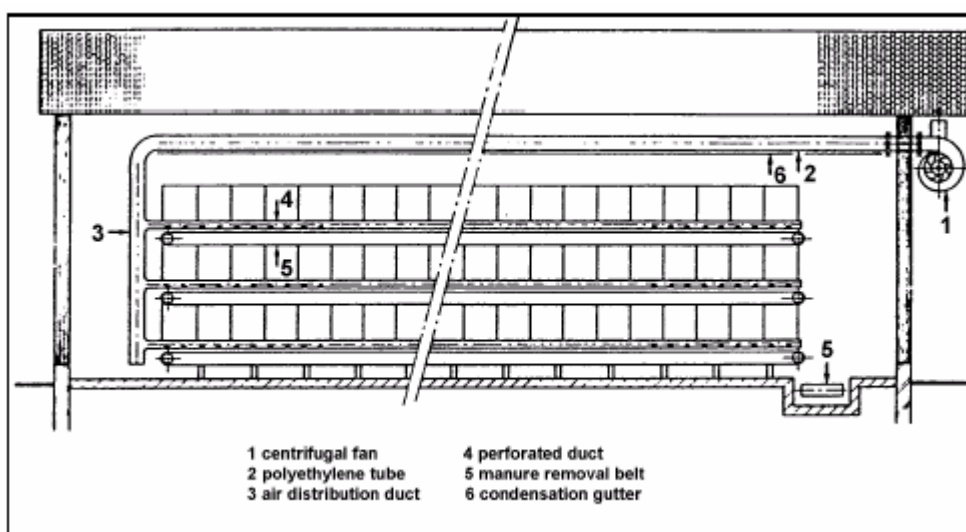

Schematic picture of a cage with forced (pneumatic) drying installation

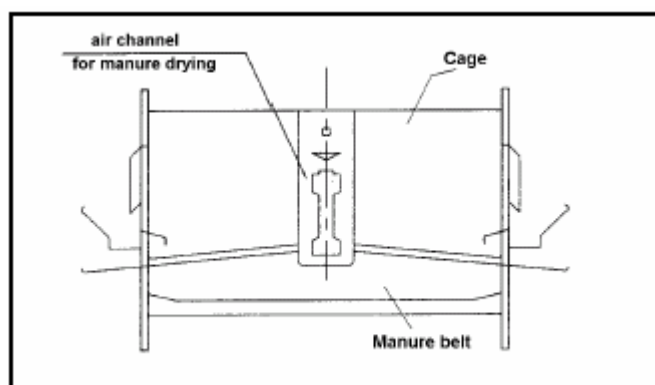

Schematic picture of a design incorporating two cages and with a manure belt and a drying channel

A3.1.4 Vertical tiered cages with manure belt with whisk forced air drying where manure is removed at least once a week to covered storage (BREF 4.5.1.5.2)

Description: This system has the same design principle as the previous system (3.1.3). A series of whisks are situated above the belt, with one whisk per set of two cages (back to back). Each whisk is operated by a connecting rod, which drives all the whisks in the row simultaneously, moving the air onto the manure on the belt. The difference from before is that

the drying air is not collected from the outside, but is just the internal air moved over the manure belt. This can be an advantage because there is no need to preheat the air or to use heat exchangers, as is the case with air recirculators (subsequently there is also no dust clogging problems as on the exchangers or in the air ducts). The manure is removed from the house once a week, with a dry matter content of at least 50 %.

Achieved environmental benefits: The emission from this system is about 0.089 kg NH₃ per bird place per year (I). This represents a 40 % reduction in comparison with the reference system, with an emission level of 0.220 kg NH₃ per bird place per year (I).

Cross-media effects: The energy consumption of moving the whisks is lower than the energy consumption of the perforated duct system. However, there is some noise associated with the whisk movement.

Operational data: As with the previous system (3.1.3), it is also possible to get low NH₃ emissions with this system. Because of the continuous air recirculation the climate in the house is good and the temperature throughout the house is uniform. Also, there appears to be less odour in the house in comparison with the previous technique.

Applicability: This system can be applied in new and existing buildings. It can be built in tiers, from 4 to 8. The whisk installation could possibly be added to an existing belt cage system which does not have drying equipment, but no practical example has been submitted.

Costs: Compared with the reference system, the extra investment is EUR 2.25 per bird place. The extra energy costs are 1.0 – 1.2 kWh per year per hen, which equates to 0.11 – 0.14 euros per year per bird place. The total extra costs (capital + running costs) are EUR 0.31 per bird place per year. This means, with a 60 % reduction of NH₃-emission compared with the reference, costs of EUR 2.32 per kg NH₃ abated.

Reference farms: The system is currently being implemented on some large poultry farms in Italy. Approximately 700000 to 800000 laying hens are kept in this system.

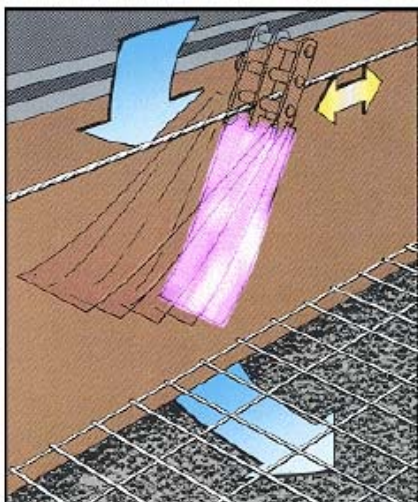

Principle of whisk-forced air drying

A3.1.5 Vertical tiered cages with manure belt with improved forced air drying where the manure is removed from the house at least once a week to covered storage (BREF 4.5.1.5.3)

Description: The principle is as described in A3.1.3. The manure is removed from the house once every five days to a covered container that must be removed from the farm within two weeks. Drying manure in this system requires the installation of a forced drying system with a

drying capacity of 0.7 m³ per laying hen per hour and an air temperature of 17 °C. The maximum drying period is 5 days, and the manure must have a dry matter content of at least 55 %.

Achieved environmental benefits: The NH₃ emission from this system is 0.010 kg NH₃ per laying hen-place per year (NL) to 0.067 kg NH₃ per laying hen-place per year (I).

Cross-media effects: Odour levels in the house are perceived to be relatively low. Noise levels are considered to be similar to that of the system described earlier in 3.1.3. A high input of energy is required to dry the manure compared with the other air drying systems, but this can be reduced by preheating the incoming air. Dust levels are lower than in the other housing systems.

Operational data: With this system it is possible to get very low NH₃ emissions from the housing. Where the air is preheated, the manure becomes drier and the climate in the cages close to the animals improves, also leading to better production results. In modern laying houses preheating the drying air is done with a heat exchanger, in which the outgoing drying air warms the incoming air.

Applicability: This system can be applied in new and existing buildings. It can be built in tiers, from 3 to 10. There is no information about existing belt-systems being additionally equipped with this drying system.

Costs: This system is a low-cost system aimed at sites with large numbers of birds wanting to make efficient use of the available space with high stocking densities. However, large differences in costs have been reported. The lower costs reported by Italy are partly due to the extra revenue generated by the higher egg prices which were applied to help offset the costs of applying the improved system. The extra investment compared to the reference system varies between EUR 0.65 (I) and EUR 2.50 (NL) per laying hen-place. Annual costs per laying hen per year vary between EUR 0.365 and 0.80 (including electricity costs). With a 70 – 88 % reduction of ammonia emission compared to the reference system, the cost efficiency varies between EUR 2.34 and 34.25 per kg NH₃ abated.

Reference farms: The system was developed in the late nineties. Currently, in the Netherlands about 2 million laying hens are kept in this system. Nowadays, these systems employing forced drying on the manure belts are implemented on large enterprises in new buildings, and in building conversions.

A3.1.6 Vertical tiered cages with manure belt with drying tunnel over cages, after 24-36 hours, the manure is removed to covered storage (BREF 4.5.1.5.4)

Description: The design of the installation is similar to the previous air-dried belt systems in principle. The manure is collected on the belts under the cages and taken to one end of the row of cages. From here it is lifted up to drying belts within a drying tunnel above the cages, the drying tunnel running along the whole length of the row of cages. The manure is spread on the belts in the tunnel, where it dries. At the end of a complete run from one end of the tunnel to the other, the manure is discharged from each belt to the lowest belt inside the tunnel, which collects all the dried droppings and makes a last run to the opposite end. This action means that by the end of a full run the manure has a high dry matter content. The tunnel is ventilated by a centrifugal fan, which emits the air out of the roof through a chimney. The drying air is taken from inside the house, at the two opposite ends of the tunnel. The belts are moved every few minutes and the whole run inside the tunnel takes 24 – 36 hours.

Achieved environmental benefits: Ammonia emission has been reported to be 0.015 (NL) to 0.045 (I) kg NH₃ per bird place per year. The manure can reach a very high dry matter content of close to 80 %.

Cross-media effects: Energy is required for ventilating the drying tunnel. The actual energy input will depend on the size of the installation (number of cages) and the resistance to airflow in the tunnel itself. Further information is needed to assess how changes in the design and operation might affect the energy requirements. By drawing away the inside air, the level of odour is thought to be very low.

Operational data: This system is typically operated in combination with house ventilation. Both ventilation systems will have to be synchronised so as to avoid any interference, as this could affect the operation of the tunnel system.

Applicability: It has been applied to cage systems with 4 to 6 tiers. The refurbishing or conversion of existing cage systems has not been reported, but application in existing buildings will require adaptations to the roof to add chimneys to exhaust the drying air. The height of the chimneys will affect the fan capacity and the energy input. Also, external storage of the dried manure is required (containers or other).

Costs: Costs are reported from Italy. The extra investment is EUR 2.79 per bird place. The extra costs for energy are 2.0 – 2.5 kWh per year per hen, equalling EUR 0.23 – 0.28 per bird place per year. The total extra costs (capital + running costs) are EUR 0.48 per bird place per year. This means, that for a 80 % reduction of NH₃-emission compared to the reference system, EUR 2.74 per kg NH₃ abated.

Reference farms: In Italy, approximately 1 million laying hens are kept in this system.

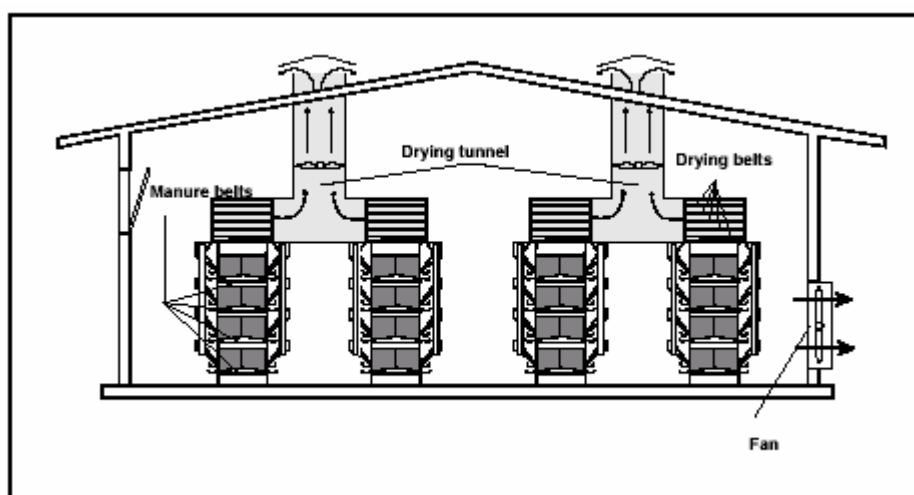

Schematic picture of a drying tunnel over vertical tiered cages

A3.1.7 Barn and free-range systems with deep litter system with forced air drying (BREF 4.5.2.1.2)

Description: This is based on the deep litter system for laying hens (described below) but here the ammonia emission is reduced by applying forced ventilation. Forced ventilation is applied through tubes that blow 1.2 m³ of air per bird place per hour at a temperature of 20 °C over the manure stored under the slats or over the manure being removed by the (aerated) belts.

(Deep litter system description: The layer house is a traditional building with respect to walls, roof and foundation. Thermally insulated poultry houses have forced ventilation; either windowless or with windows for natural daylight. Birds are kept in large groups with 2000 to 10000 bird places per housing facility. The air is replaced and emitted passively by natural ventilation or by forced ventilation with negative pressure. In accordance with EU Egg Marketing Standards currently in effect, at least one third of the floor area (concrete floor) must be covered with bedding (chopped straw or wood shavings used as litter material) and two thirds arranged as droppings (manure) pit. The pit is covered with slats that are mostly made of wood or artificial material (wire meshing or plastic lattice) and slightly raised. Laying nest, feed installation and the water supply are placed on the slats to keep the litter area dry. The manure is collected in a pit below the slats during the laying period (13 – 15 months). The pit is formed by the raised floor or can be sunk into the ground. Automatic supply of feed and drinking water, with long troughs or automatic round feeders (feeder pans) and nipple drinkers or round drinkers are installed above the pit area. Droppings are removed from the pit at the end of a given laying period; or intermittently, with the aid of (aerated) manure-belts. At least one third of the used-air volume stream is drawn off via droppings pit. Individual or community nests are provided for laying; automatic egg collection is also possible. Lighting programmes to influence performance/rate of lay and crude protein adapted feeding may be applied.)

Achieved environmental benefits: The application of forced ventilation and quick drying of the manure reduces emissions to 0.125 kg NH₃ per bird place per year for the pit storage. The ammonia reduction of this system is 60 % compared to the reference system (0.315 kg NH₃). Frequent removal with (aerated) manure belts can be expected to give even lower emission levels.

Cross-media effects: Reduced odour levels can be expected compared to the reference system. The energy input in this system is high, because a heating system must be installed to achieve the 20 °C temperature necessary in the tubes. Extra energy is also required to maintain the airflow. Air is drawn in through inlets in the sidewalls and through an open ridge construction in the roof.

Operational data: Management of this system is principally the same as of the reference deep litter design.

Applicability: The system can only be used in laying hen houses with enough space underneath the slats. Traditionally the manure pit has a depth of 80 cm, but when using this system it is necessary to add an extra 70 cm. The experience from farmers already using the deep floor system is that they like this type of system because it requires very little change to the traditional design.

Costs: Compared with the reference system, the extra investment costs are EUR 1.10 per bird place. The extra annual costs are EUR 0.17 per bird place. This means that with a 60 % ammonia reduction (0.315 to 0.125 kg NH₃), the cost is about EUR 5.78 per kg NH₃ abated.

Reference laying hen-places: This system is very new; only one farm (40000 laying hens) in the Netherlands uses this system and about 5 % of the farms in Germany. It is expected that application of this system will increase in the future.

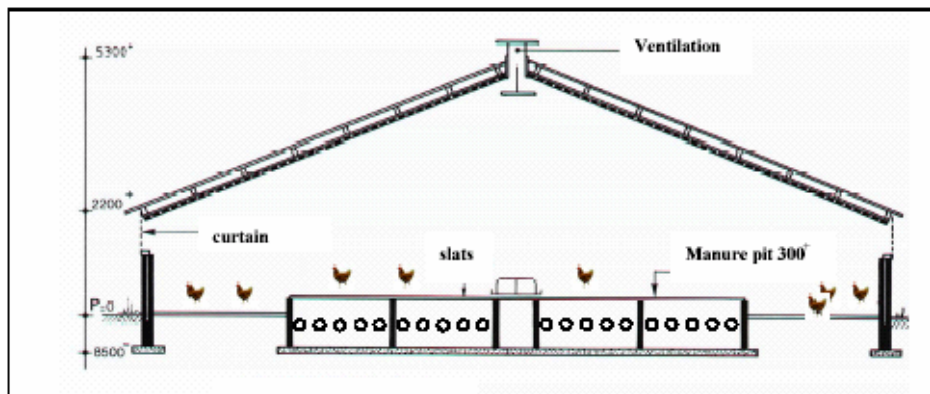

Deep litter systems with forced drying via tubes under the slatted floor

A3.1.8 Barn and free-range systems with deep litter system with perforated floor and forced air drying (BREF 4.5.2.1.3)

Description: The layer house is traditional (walls, roof, etc.) The ratio of litter to “slatted floor” is 30:70. The laying nest area is included in the slatted floor area. There is a perforated floor underneath the manure and the slats, which allows transportation of the air used to dry the manure on top of it. The maximum load of this perforated floor is 400 kg/m². The distance between the bottom of the pit and the perforated floor (air-channel) must be 10 cm. The perforated floor has a total area of air openings of 20 % of the surface area.

Achieved environmental benefits: It is possible to obtain a 65 % reduction in NH₃-emissions (0.110 kg compared to the 0.315 kg NH₃ per bird place per year of the reference system).

Cross-media effects: Higher energy input is required because of the forced ventilation.

Operational data: The layer droppings fall through the slats onto the perforated floor. At the beginning of the laying period the perforated floor is provided with a 4 cm thick bed of woodshavings. The (preheated) air is blown from beneath through the small openings in the perforated floor under the manure. To dry the manure properly, ventilators with a total capacity of 7 m³ air/hour at 90 Pascal are installed. The manure stays on the perforated floor for about 50 weeks (laying period) and is then taken out of the house. The minimum distance between the perforated floor and the slats is 80 cm. The manure is dried constantly by the continuous flow of air. The dry matter content of the manure is about 75 %. The farmer should protect himself with a face mask. The drinking facilities must be installed on top of the slats, but good design of the tubes should avoid loss of water.

Applicability: Application in new situations is more likely, but it could also be installed in existing houses, but at an additional cost.

Costs: Investment costs are EUR 1.20 per birdplace and annual costs are EUR 0.18 per bird.

Reference farms: In the Netherlands, about 10 farms (year 2001) are currently applying this system.

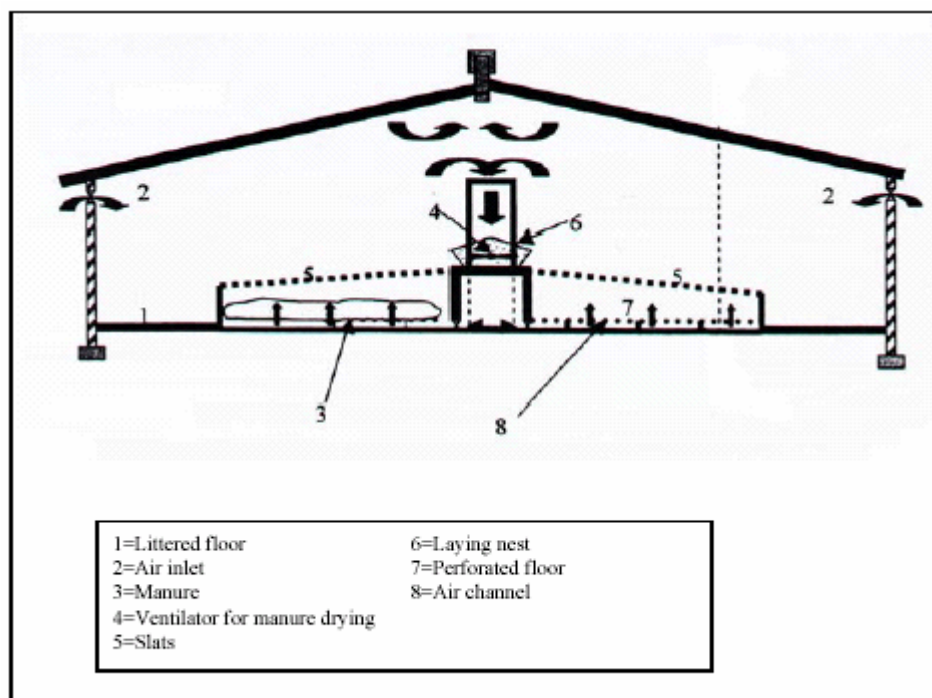

Deep litter system with perforated floor and forced manure drying

A3.1.9 An aviary system with or without range and or outside scratching area (BREF 4.5.2.2)

Description: This poultry house is a construction with thermal insulation and forced ventilation, either windowless, or with windows for natural daylight and artificial light for applying lighting programmes; houses can be combined with range and outside scratching area. Birds are kept in large groups and enjoy freedom of movement over the entire house area. Housing space is subdivided into different functional areas (feeding and drinking, sleeping and resting, scratch area, egg laying area). The birds can use several house levels that allow for higher stocking densities compared to the commonly used floor regime (deep litter). Droppings are removed via manure belts into containers, or into a manure pit, or otherwise collected in a manure pit. Litter is spread onto a fixed concrete area. Feed (mostly feed chains) and drinking water (nipple or cup drinkers) are automatically supplied. Laying nests (individual or community nest design) have manual or automatic egg collection. Stocking density is maximised to 9 birds per usable m² or to 15.7 birds per ground surface (in m²), with houses accommodating between 2000 and 20000 birds (bird places).

Achieved environmental benefits: Data on ammonia emissions have only been reported by the Netherlands, with values of 0.09 kg NH₃ per bird place per year, which is 71 % less than the reference non-cage system. This emission reduction is related to the manure removal, where about 90 % of all the manure is removed by belts at a frequency of at least once a week. The other 10 % of the manure is removed from the litter area after one cycle.

Cross-media effects: When compared to the cage regime, a distinctly higher dust content in the in-house air is reported. This gives a higher stress effect on the mucous membranes of humans and animals. Energy requirements depend particularly on the ventilation and vary between 2.70 kWh per bird place per year for non-belt systems to 3.70 kWh per bird place per year for aerated manure belt systems.

Operational data: Hens enjoy more freedom of movement than their counterparts under cage management, but replacement pullets must come from aviary grower houses. Aviary systems are more bird-friendly than, by comparison, conventional floor management systems, since the hens' living space is more heavily structured. More favourable temperature conditions in winter are observed due to a higher stocking density. Feed conversion and the rate of lay are also better than in floor regimes. The available in-house space can be supplemented by providing an outside scratching area. However, the birds can have contact with faeces, which creates a hazard from intestinal parasites. Also, the system shows a higher percentage of soiled and/or "laid-away" eggs. Another negative effect is that having larger groups and introducing natural daylight also promotes aggressive bird behaviour and incidences of feather pecking and cannibalism are possible, resulting in a higher potential loss rate. Bird observation is more difficult and medication requirements tend to be higher.

Applicability: Aviary housing systems are still little used compared with cage or floor regimes, but a reasonable amount of practical experience has been gathered. Since there is no significant demand for eggs from house-confined aviary systems, in Germany this housing system is currently only practised in combination with outdoor ranges.

Costs: Costs for the design with aerated manure belt removal total EUR 16.5 to 22.0 per bird place per year:

- labour EUR 1.2 – 2 (at EUR 12.5/hr)
- capital investment EUR 2.4 – 5.6 (11 % annual cost: 5 % depreciation, 2.5 % repair and maintenance, 7 % interest)
- operating cost EUR 12.9 – 14.4 [124, Germany, 2001]

Total costs EUR 16.5 – 22.0

Driving force for implementation: The implementation of aviary systems may increase for animal welfare reasons. Another driving force might be the decision of the EC (Commission Regulation No 1651/2001) that, in order to indicate the farming method, no terms may be used on eggs other than 'free range', 'barn' or 'cage'.

Reference farms: In general, the number of houses with aviary systems is small. Data reported by the Netherlands show that about 3 % (649000) of the layers are kept in aviaries and on less than 1 % of the farms.

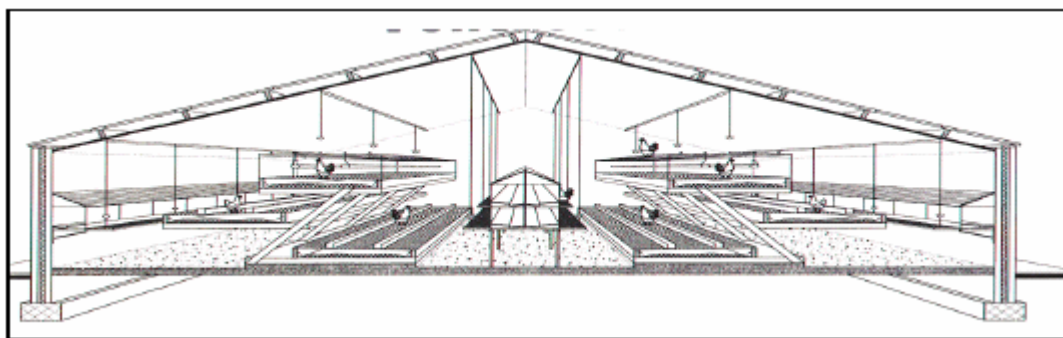

Schematic of an aviary system

A3.2 Broilers and floor reared replacement pullets

Naturally ventilated house with a fully littered floor and equipped with non-leaking drinking systems or a well-insulated fan ventilated house with a fully littered floor and equipped with non-leaking drinking systems (BREF 4.5.3)

The traditional housing of intensive broiler production is a simple closed building construction of concrete or wood with natural light or windowless with a light system, thermally insulated and force-ventilated. Buildings are also used that are constructed with open sidewalls (windows with jalousie-type curtains); forced ventilation (negative pressure principle) is applied by way of fans and air inlet valves. Open houses must be located so that they are freely exposed to a natural stream of air and are positioned at a right angle to the prevailing wind direction. Additional ventilating fans operate via ridge slots, and gable openings may apply. This is intended to provide the in-house broiler area with extra air circulation during hot spells in summer. Mesh wire screens along upper sidewalls keep wild birds out.

Closed buildings have oil- or gas-fired warm-air blowers for total room heating; radiant heaters are used for zonal heating in houses built for open-air ventilation. Artificial lighting and/or artificial/natural daylight combination lighting system are provided as required.

Broilers are kept on litter (chopped straw, wood shavings or shredded paper) spread over the entire house floor area which, in turn, is built as a solid concrete slab. Manure is removed at the end of each growing period. Automatic, height-adjustable feeding and drinking systems (mostly tube feeders with round feeder pans and nipple drinkers with drip water catch bowls) are applied. Crude protein-adapted feed is given. Broilers are kept at a stocking density of 18 to 24 birds per m². Stocking density is also measured in kg live weight/m² (e.g. in Finland), but this number is variable. New legislation is expected to limit the stocking density of broilers. Houses can stock between 20000 and 40000 birds.

Both for animal welfare reasons and to minimise ammonia emissions wet litter must be avoided. The dry matter content of the litter depends on:

- the drinking system
- length of the growing period
- the stocking density
- the use of floor insulation.

In the Netherlands a new housing technique was designed to avoid or minimise wet litter. In this improved design (known as VEA-system, the Dutch abbreviation for “broiler low emission housing”) attention is paid to the insulation of the building, to the drinking system (to avoid spillage) and to the application of wood shavings/sawdust. However, accurate measurements in fact show that both the traditional system and the VEA-system have the same ammonia emissions of 0.08 kg NH₃ per broiler place per year (NL).

The emission level 0.08 kg NH₃ per broiler place per year is considered as the reference level. It is obvious that as the ventilation rate depends on the natural airflow, design of the house and both the air inlets and outlets is crucial. Energy consumption (and costs) is lower than with the fan-ventilated house.

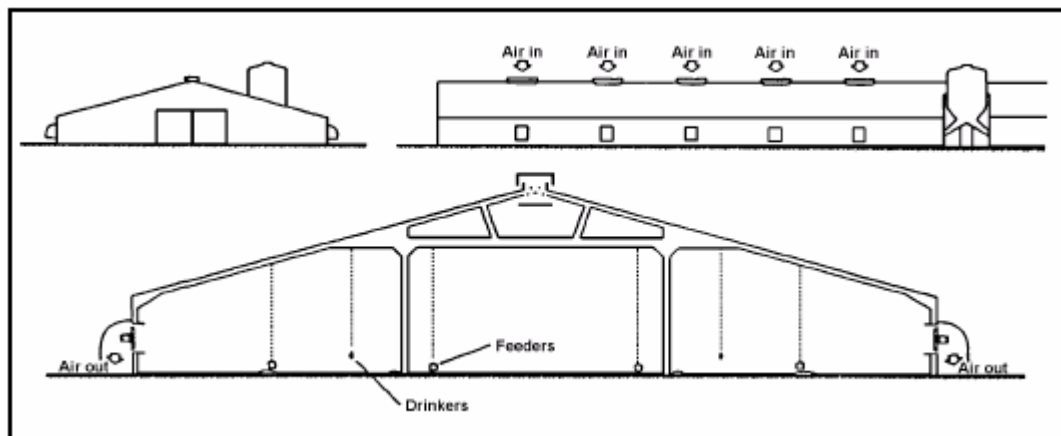

Schematic cross-section of a traditional closed broiler house

A3.3 Turkeys

Naturally ventilated house with a fully littered floor and equipped with non-leaking drinking systems or a well-insulated fan ventilated house with a fully littered floor and equipped with non-leaking drinking systems (BREF 4.5.3)

The commonly applied turkey housing is a traditional housing construction, which is very similar to the housing of broilers (see A3.2 above for details). Turkeys are housed in closed, thermally insulated buildings with forced ventilation, or (more frequently) in open (outdoor-climate) houses with open sidewalls and jalousie-type curtains (unrestricted natural ventilation). Forced ventilation (negative pressure) is applied by fans and inlet valves. Free open-air ventilation is created via automatically controlled jalousies or wall-mounted inlet valves. Open houses are aligned at right angles to the prevailing wind direction and located in such a way as to be exposed to natural airflow. Additional ventilation is applied via ridge slots and gable openings. Radiant gas heaters are applied for heating.

Precautions are put in place to protect against emergencies like power cuts, extreme weather conditions or fire, as per unit a large number of birds will always be at risk. During peak summertime temperatures, additional measures are taken to minimise heat stress on the birds (by providing for larger-volume air change, operating extra fans for bird comfort in open houses, water fogging or roof sprinkling)

Wire meshing in the upper sidewall section is applied to keep wild birds out. A floor regime is operated with litter material (chopped straw, wood shavings) spread over the entire house floor area (built of concrete) with layers up to 9 – 12 inches deep. Manure removal and cleaning of the house takes place at the end of each respective growing period. All litter is removed by an excavator or frontloader. Litter replenishment is applied as needed. Automatic height-adjustable round drinkers and feeders are applied during the growing/feeding period. Daylight length and light intensity can be controlled during brooding and, in closed houses, over the entire brooding/finishing period.

A3.4 Ducks

Unrestricted naturally ventilated house or a well insulated fan ventilated house with a partly-slatted floor with impermeable drainage channels and effluent storage area or

A fully slatted floor with impermeable drainage channels and effluent storage area or

A fully littered floor with a water system positioned above a gully and covered drainage channels and effluent storage areas (BREF 2.2.3.2)

Ducks are kept in housing, although in some Member States outdoor rearing is also allowed. There are three main housing systems for fattening of ducks:

- fully littered, with a water system positioned above a gully
- partly slatted/partly litter
- fully slatted.

The commonly applied duck house is a traditional housing system and is similar to the broiler house (see A3.2 above for details). It has a concrete floor that is covered with litter. The house is equipped with a ventilation system (natural or mechanical) and, depending on the climatic conditions, heating is applied.

Production cycles will vary between Member States. In Germany, the production cycle for duck meat production is divided into a growing period up to day 21 followed by a finishing period until day 47 – 49. Rearing and growing is done in separate stalls. Manure is removed and the stalls are cleaned and disinfected during a service period of about 5 to 7 days before they are stocked again. Stocking density is 20 kg live weight/m² accessible floor area in both phases, with accessible areas typically measuring 16 x 26 m for growing and 16 x 66 m for finishing. Thus, the growing stalls can house approximately 20000 young ducks and the finishing stalls about 6000 ducks.

Commonly applied is the fully littered system using wheat or barley straw or wood chips. The layer is usually not too thick because the manure of ducks is much wetter than that of chicken broilers. Slats, if applied, are usually of plastic-coated wire, wood or synthetic material.

Appendix 4 Odour management at intensive livestock installations

A4.1 Background

This appendix provides guidance on the sources of odour from intensive livestock farms and the measures to minimise these odour emissions. You should refer to Horizontal Guidance for odour (H4) for details on odour pollution, odour assessment, odour management plans and the complaints procedure.

You should use this guidance if:

- there are sensitive receptors (neighbours) located within 400m of the installation; and/or
- the installation has a history of substantiated odour-related complaints within the last three years; and/or
- you are in the process of planning for a new installation, or extending an existing one.

Sensitive receptors are primarily people in dwellings, hospitals, schools and similar premises, but can include people frequenting open spaces, for example, parkland. The person in control of the installation would not normally be considered to be a sensitive receptor. People who live in close proximity in tied housing may be sensitive receptors (consider the families of the farm workers). If such properties are rented to people who do not work on the farm, the tenants are likely to be sensitive receptors, even if they rent with the knowledge that there is an odour source nearby, or recognise that odour is a feature of the rural environment.

In any particular situation however, the interpretation of the courts will be the decisive factor.

A4.2 Sources of odour

A4.2.1 Livestock housing

The odour associated with livestock housing tends to be related to ammonia. Hydrogen sulphide can also be present. High ammonia concentrations usually accompany high odour concentrations in broiler buildings where litter is in poor condition (too wet), but ammonia should only be seen as a component of the overall odour. Many of the actions taken to minimise odour will also minimise ammonia.

A4.2.2 Manure and slurry

Odour arises primarily from the presence of manure/slurry and the biological changes which take place as it decomposes and also the body odour of the livestock. Some odour also arises as a result of cleaning and disinfection of sheds - from the removal of accumulated manure and also from fumigants used. Storage of manure or slurry in the open is also a source of odour.

A4.2.3 Dust

An important mechanism in the release to atmosphere of odour may be the presence and subsequent emission via the ventilation system of suspended dust particles originating from bedding, feed and the animals themselves. Odorous compounds may be adsorbed onto these particles and the particles themselves may decompose releasing volatile compounds.

A4.2.4 Factors affecting the release of odour

The level of odour emissions from intensive livestock installations is dependent on a number of factors, principally:

- size of operation;
- the type of building/ventilation;
- type of operation and the rearing cycle;
- the feeding regime;
- the way in which the operation is managed;
- storage arrangements for manure and slurry;
- land spreading practices.

The impact of those emissions on the local environment depends upon:

- proximity to local housing and other sensitive receptors;
- the nature of the local topography and prevalent weather conditions.

A4.3 Management of odour

A4.3.1 General aspects of odour management

A4.3.1.1 Overview

The nature of intensive farming means that preventing odour generation at source is rarely possible as animals are inherently odorous. However, there are many things that can be done, often at low cost, to minimise odour or to prevent it reaching neighbours. Odour management is site specific - you will need to pick out those elements which most closely match your circumstances and add in any other sources or problems.

In most cases, attention to housekeeping and good operational practices should achieve a significant reduction in the level of exposure experienced at sensitive receptors.

In cases where all reasonable measures have been taken and have failed to reduce emissions to the point where the exposure of sensitive receptors is acceptable then 'end of pipe' abatement may need to be considered. This may require odour to be contained at source and extracted to an abatement system with minimum fugitive losses. Biofilters or absorption 'scrubber' systems (chemical or biological) are the favoured choice because of their effectiveness and ease of operation. This is obviously a more expensive option so all effort should be made to improve the housekeeping aspects of the operation. Guidance on such systems is beyond the scope of this document.

A4.3.1.2 Using location/siting as a means of odour control

You should take care to site particularly odorous activities away from neighbours. Distance helps to dilute odours and making sure that odour sources are not upwind of houses (i.e. the prevailing wind direction) helps in reducing the impact of odours.

Although the siting of the installation will have been considered as part of the planning application, there may be some choice, for example, in the siting of slurry and manure storage areas, deciding what will be spread on fields near houses and what spreading techniques are used. The day to day operation of the installation is under the control of the installation operator who can play a major part in reducing odour levels.

A4.3.1.3 Landscaping (tree planting and earth banks) as an odour barrier

Vegetation barriers (trees and hedges) and earth banks are sometimes said to provide a degree of odour control if planted between the source and local dwellings. However there is

no evidence that landscaping has any effect in dispersing the odour. The psychological effect of removing the odour source from view probably has a much greater overall effect on the perception of odour rather than the actual odour reduction offered.

A4.3.1.4 The use of odour masking/neutralising agents (air spraying)

The use of additives to mask, counteract or neutralise odour are only generally suitable for short term operations, such as transfer of material or for addition to a particularly odorous batch of slurry. They should not be regarded as a long term approach and, indeed, would not generally be cost effective in the long term.

The smell of masking agents can often attract as many complaints as the smell they are trying to cover.

A4.3.3 Odour management actions common to all operations

Problem	Actions to prevent or minimise odour
Animal feed	<p>Selection and use</p> <p>Chapter 2 gives guidance on the selection and use of feeds at different stages in the rearing cycle in order to reduce nitrogen excretion. A high protein diet increases the nitrogen and sulphur content of manure, contributing to emissions of ammonia to air and potentially other odorous compounds when the manure undergoes anaerobic degradation.</p> <p>Feed additives</p> <p>A number of different feed additives are available which claim to reduce odour from manure. In most cases these have not been proven sufficiently well for any to be recommended.</p>
Feed delivery, milling, preparation and storage	<p>Good housekeeping</p> <ul style="list-style-type: none"> • avoid accumulation of waste feed; • clean up spills; • avoid overflow and spillage from feed and drinking systems. <p>Reduce dust emissions</p> <p>Odours may be absorbed onto particulate matter and then carried out of the building via the ventilation system. Avoid finely ground feeds and long feed drops onto floors as they increase dust emissions.</p> <p>Closed systems</p> <p>Carry out mixing and milling of dry foodstuffs using closed systems or in an environment from which emissions can be minimised.</p> <p>Deliver the feed to the storage areas, and from the storage container to the feeding station through a closed system to minimise dust generation.</p> <p>Cover storage</p> <p>Cover feed storage areas or use purpose built silos. You should</p>

	<p>protect these storage areas from collision damage.</p> <p>Storage of odorous by-products</p> <p>The addition of odorous by-products such as whey and fish meal to feed may increase the odour level of the feed (and accumulated spillages will smell more). Storage of these products may also lead to odour and dust generation.</p>
<p>Carcass disposal</p>	<p>Removal frequency</p> <p>Remove carcasses frequently to prevent odours building up.</p> <p>Cover storage</p> <p>Cover carcass stores to prevent access by birds or rodents using plastic bags or lidded bins where possible (see section 3.2)</p>
<p>Ventilation and humidity</p>	<p>Operation</p> <p>Ventilation rates are determined by the needs of the animals and vary with season. Odour will be carried out of the houses with exhausted air and the exhaust rate will tend to be highest when the outside temperature is high. This generally occurs in the summer months when the potential to cause odour annoyance is highest.</p> <p>Ventilation systems should be run at the optimum rate for the number of animals present. Insufficient ventilation capacity can lead to excessively high room temperatures which increase slurry/manure decay rates and hence odour emissions.</p> <p>Atmospheric dispersion</p> <p>Once odorous emissions leave the source they undergo dilution and dispersion in the atmosphere downwind of the installation. Where odours are released at height, they are likely to be more effectively dispersed than those released at a low level or, inadvertently, from open doors.</p> <p>The design of ventilation systems is a specialist field but in general terms roof (apex) vents produce better dispersion of odorous releases than those positioned along the side of buildings (side wall vents). Increasing the height of vent discharge points above roof level may give better dispersion. Ducting the ventilation flow to a single stack, which emits at a much higher level will provide still further improvement although may have the effect of making the odour detectable further away than was previously the case. Stack height calculation can be fairly complex and needs to consider a number of aspects relating to the emissions and the rate of emission, the temperature, the local topography and the location of receptors. It is best undertaken by a specialist.</p> <p>Clear dust deposits</p> <p>Clear dust deposits around the ventilation discharge points on a regular basis to prevent excessive buildup.</p>
<p>Dirty water management</p>	<p>Prevent stagnation</p> <ul style="list-style-type: none"> • fit kerbs to concrete aprons to direct dirty water into collection

	<p>tanks;</p> <ul style="list-style-type: none"> • enclose dirty water collection systems; • empty and clean dirty water collection systems to avoid allowing anaerobic conditions to develop in settled sludge; • maintain drains and concrete areas; • quickly deal with dirty water generated when buildings are cleaned out at the end of the cycle.
--	--

A4.3.4 Odour management in pig rearing (housing)

The principal sources of odour during rearing are slurry or manure and bedding material. The way in which the slurry or manure is collected in the pig houses, i.e. underfloor and/or on the floor, the amount, the temperature and residence time will affect the amount of odour generated. Odour emissions from the housing can be minimised by keeping the pig pens clean, i.e. by continually removing the slurry and regular removal of soiled straw or manure by flushing or scraping.

Other sources of odour are:

- the pigs themselves, both body odour and any manure on the skin;
- spilt feed;
- carcasses.

A4.3.4.2 Minimising odour from pigs and their housing

In general terms:

- odour emission rate increases with an increase in slatted floor area;
- wintertime emissions are lower than summertime emissions;
- ventilating the pit increases odour emissions substantially.

Techniques to abate emissions will depend on the type of housing and slurry or manure collection systems in place. For slurry based systems, techniques are aimed largely at reducing the surface area of the slurry, and to reduce the area of flooring which is damp. For manure based systems, which may be releasing odour, increasing the available straw will bind nitrogen and prevent ammonia and odour escaping.

Anaerobic breakdown (in the absence of oxygen), unless deliberately induced as a method of treating slurry, is highly odorous and should be prevented by avoiding stagnation of wastes.

Problem	Actions to prevent or minimise odour
Pig housing general hygiene	<p>You should maintain a good standard of general cleanliness for animal welfare as well as for odour control. Any surface which is covered with manure will act as a source of odour. - reducing the exposed surface will reduce the overall odour emission. Surfaces include the animals themselves, as well as pens and flooring, in addition to areas around the buildings.</p> <p>Dirty pens can be caused by a number of factors, for example:</p> <ul style="list-style-type: none"> • poor management and building design;

	<ul style="list-style-type: none"> • poor ventilation design and inadequate ventilation capacity; • wrong pen shape; • poor floor surfaces; • incorrect construction of pen divisions; • badly sited feeding and watering facilities; • overstocking or understocking; • poor differentiation between feeding, lying and dunging areas in pens. <p>Some of these are design issues and should be addressed when planning new facilities or extending or replacing existing houses.</p>
<p>Pig housing slurry systems</p>	<p>Keep the pig pens clean</p> <ul style="list-style-type: none"> • remove slurry and manure to a suitable store as frequently as possible; • thoroughly clean and disinfect pens once vacated; • clean slurry and drainage channels to clear deposits, which encourage microbial growth; • clean surfaces and ventilation shafts/cowls of dust deposits; • maintain drinkers and troughs to prevent leakage.
<p>Pig housing solid floor systems</p>	<p>Keep the pig pens clean</p> <ul style="list-style-type: none"> • Provide drainage to avoid the accumulation of effluent in areas where it may collect and start to degrade in an anaerobic manner. The drained liquid should be collected in a closed tank. • Repair damaged concrete and drains to prevent ponding inside buildings. • Use sufficient bedding material to absorb excreta and keep animals clean. • Maintain drinkers and troughs to prevent leakage. • Store bedding material in a dry area.
<p>Pig housing flooring</p>	<p>Floor design</p> <p>Floor design may be the most important measure which can be taken to reduce the odour emissions from slurry based pig buildings e.g. use of part slatted rather than fully slatted flooring.</p> <p>Management</p> <ul style="list-style-type: none"> • Clean slats, pens and other surfaces at the end of the batch. High pressure hoses provide an effective means of removing accumulated deposits. • Maintain scraped areas to prevent ponding or building up of urine.

	<ul style="list-style-type: none"> • Regularly remove or flush away slurry and manure - the underfloor storage of large amounts of slurry over a prolonged time is a major source of odour. • Repair damaged flooring as soon as possible.
--	--

A4.3.5 Odour management in poultry rearing (housing)

Odours from poultry housing come from a number of sources. They are mainly caused by the breakdown of droppings and litter. Other sources of odour are from animal feed and waste food spilt onto floors. A major means of minimising odour emissions is through the use of good agricultural practice. Odour mitigation methods will be similar for all different poultry operations.

The following factors contribute to the emission of odours from poultry housing:

- build up of slurry or manure on concrete around buildings;
- removal and disposal of dead animals;
- drain maintenance;
- bedding cleanliness;
- management of drinking systems, with particular emphasis on frequently adjusting nipple and drip cups to bird eye level to avoid spillage and wet litter;
- stocking density;
- litter moisture content;
- insulation of the buildings and the long term maintenance of that insulation;
- ventilation and heating system;
- type of heating;
- composition of the feed, particularly its oil and fat content and its protein content.

The housekeeping practices at a well-run poultry operation should take these factors into account as part of their day to day management/operation of an installation.

A4.3.5.2 Minimising odour from poultry and their housing

Odour from litter and manure based systems may be minimised by increasing the dry matter content of the litter or manure, by both preventing spillages of water and providing a drying mechanism. If the dry matter content is 60% or above, ammonia emissions are minimal. New buildings should be able to meet this.

Problem	Actions to prevent or minimise odour
Dust	<p>Dust emissions may be a problem particularly for larger birds. Odorous compounds may be adsorbed onto dust particles and the particles themselves may decompose releasing volatile compounds. It is important to:</p> <ul style="list-style-type: none"> • Control the generation of dust within the house through management of litter moisture content and air quality. • Minimise the amount of dust emitted from buildings.

	<ul style="list-style-type: none"> • Ensure dust deposits around ventilation discharge points are cleared on a regular basis to prevent excessive build up. Minimising dust production through good housekeeping and animal husbandry would be cost effective, in addition to the obvious welfare benefits. • Collect the water discharging from cleaning operations in sealed tanks. <p>The odour emission from a building can be dependent on particulate emission. Data suggests that removing the dust fraction from an odorous stream reduces the odour concentration by about 65%.</p>
<p>Litter quality</p>	<p>Litter quality is affected by:</p> <ul style="list-style-type: none"> • temperature and ventilation; • drinker type and management; • feeder type and management; • litter material and depth; • condensation; • stocking density; • feed formulation and quality; • bird health. <p>Investigate the minimum ventilation and heating requirements. In new houses ventilation should be designed to remove moisture.</p> <p>Investigate increasing the initial depth of litter. A depth maintained at 10-15 cm should be sufficient to absorb the moisture loading.</p> <p>Litter removed from the buildings at the end of the production cycle should be stored dry. The storage area should be away from residential areas.</p> <p>In egg production a belt manure removal system (ideally with forced air drying) should be used to avoid the accumulation of manure from caged layers. Where manure falls directly into a deep pit, ventilation of the pit should be provided to keep the manure dry.</p> <p>Duck manure tends to have a higher water content (around 30% dry matter) than other poultry litters, but the need for good hygiene and management practices are still relevant.</p> <p>For all litters, the following measures will help to minimise odour emissions:</p> <ul style="list-style-type: none"> • remove of dead animals; • maintain of drinking systems; • provide sufficient straw/litter to bind nitrogen and prevent ammonia escaping.
<p>Drinking systems</p>	<p>The management of drinking systems should ensure that all litter is</p>

	<p>kept dry i.e. moisture content is less than 40%.</p> <ul style="list-style-type: none"> • Check systems for leaks and take action taken as necessary. • Use nipple drinkers and drip cups (operate on demand) in preference to bell drinkers (always full of water). • Site drinkers at the correct height to minimise spillage.
--	--

A4.3.6 Odour and manure management

A4.3.6.1 Slurry and manure handling

Slurry and manure handling and storage can be significant sources of odour - reducing odour from these sources can have a substantial positive effect on the overall odour impact of the installation on local receptors. In particular, anaerobic conditions can lead to the formation of high concentrations of odorous substances within slurry which will be released during 'bubbling off' or when it is disturbed.

Problem	Actions to prevent or minimise odour
Slurry and manure handling	<p>Roadways/yard areas</p> <p>Keep roadways and other areas e.g. areas around buildings and yards, free of slurry or manure.</p>
Slurry and manure storage	<p>Store location</p> <p>Store slurry and/or manure storage areas and any material separated from the slurry or any straw based manure as far away as possible from residential areas.</p> <p>Slurry store cover</p> <p>Covering or enclosing slurry stores will stop or significantly reduce odour escaping to atmosphere. Section 3.2 requires that new and expanded slurry stores are covered. Proposals for covering existing slurry stores must be submitted. The options are to fit a rigid cover to a steel or concrete tank, or to use a floating cover of light expanded clay aggregate. Other covers, such as straw or peat will sink and do not reduce emissions effectively.</p> <p>Fixed covers will reduce emissions, but the concentration of odour in the headspace can become very high. This may be released in one go when the cover is removed, producing very strong odours at receptors if not dispersed adequately in the air. This may cause particular annoyance, even if short lived. There may also be health and safety implications if workers are exposed to the air in the tank headspace.</p> <p>Floating covers have the advantage of no headspace but will only work effectively if disturbance to the surface is minimised. A floating cover of aggregate will not trap odorous digester gases produced during 'bubbling off' in settled solid in slurry stores.</p> <p>Some more permanent floating cover designs have an extraction system to remove gas.</p>

	<p>New open slurry stores will not be allowed and plans must be in hand to replace or cover existing open tanks.</p> <p>Slurry management</p> <p>Reducing the surface area will help in reducing odour emissions. Any form of agitation or turbulence from pumping or stirring will increase the odour from the surface of an open tank. Bottom filling will minimise surface emissions. Formation of a crust may provide a degree of protection against odour emissions but turbulence from stirring can break the crust.</p> <p>It is recognised that slurry mixing may be necessary to produce a suitable material for land application, but generally the preceding measure will reduce emissions of ammonia and odour. The frequency of stirring should be minimised.</p> <p>Manure storage</p> <p>Many of the requirements relating to storage of manure are aimed at avoiding the pollution of water courses by run-off. Odour minimisation is provided largely by keeping manure undercover in a storage building.</p>
<p>Slurry and manure treatment</p>	<p>There are various options for slurry treatment, including screening, separation, composting, aeration and anaerobic digestion. Their use should be considered on a case-by-case basis. In general:</p> <ul style="list-style-type: none"> • Separation of sludge by mechanical means, aeration or digestion can reduce the odour emitting potential. • If an aerobic or anaerobic system is used to reduce the odour emission it should be large enough to handle all the slurry produced, and designed for this purpose. It should be operated according to the manufacturers instructions. • When using aerobic treatment methods, odour reductions and overall control is better when solid content is reduced. • Monitoring should be undertaken to ensure that the appropriate conditions are maintained, particularly in the case of aerobic digestion. • The solid content of the slurry store should be reduced using a separation stage. With less solid material present the need for stirring is reduced. <p>Slurry separation</p> <p>The management of slurry can be improved by removing coarse solids. For example, for pig slurry comprising 2 to 4% dry matter, a simple wedge screen or vibrating screen can be used and the collected solids (8 to 12% dry matter) will self-drain if held in a suitable store. Separators that press, squeeze or screw the slurry against a fabric or perforated steel screen will produce a solid with a dry matter content ranging from 18 to 30%. If slurry is left in the collection pits for more than 3 to 5 days, degradation of material structure (becomes more fluid) can be expected making the</p>

	<p>separation process more difficult.</p> <p>The solid portion, 10 to 20% of the original slurry volume, can be stacked and stored in a similar way to farmyard manure. At higher dry matter levels the material will be suitable for composting. The separated liquid portion, which is 80 to 90% of the original, can therefore be pumped to store. Once separated, storing the liquid portion is easier because there is less risk of crust formation and solid settling and therefore mixing in store only needs to be carried out occasionally which results in a reduction of odours released during storage.</p> <p>If solids are not removed from the slurry, the organic loading within the slurry store (lagoon or tank) will become increasingly anaerobic. The presence of solid material provides an additional demand on available oxygen, thus increasing the amount of ammonia and hydrogen sulphide produced when the slurry is agitated.</p> <p>Composting</p> <p>Composting can significantly reduce the odour from manure. However the composting process itself can be very odorous.</p> <p>The presence of oxygen is essential to the composting process and to prevent odorous anaerobic breakdown. Manure should be stored in narrow windrows no longer than 10-15m long and no taller than 3m high to assist composting. A method of collecting any run-off from the store should be provided.</p> <p>Slurry and manure additives</p> <p>There are a number of additives available which aim to change the qualities of the manure for a number of reasons, for example to improve its handling qualities, its fertilising value, its stability or to reduce the emission of volatile compounds and odour by changing its chemical composition.</p> <p>In most cases these have not been proven sufficiently well for any to be recommended, although there are a number of anecdotal success stories.</p> <p>Other treatment methods can be used to control odour emissions during storage. Additives are commercially available that claim to control odour emissions; the main types are:</p> <ul style="list-style-type: none">• oxidising agents;• deodorants which react with odorous compounds;• odour masking agents;• odour neutralising agents;• biological agents – enzymes, bacteria;• feed additives. <p>These additives vary in effectiveness and are generally not a long-term solution. Their use has not been included as an appropriate measure.</p>
--	--

A4.3.7 Slurry and manure spreading

Odours released from manure or slurry spreading activities are one of the most frequent sources of odour complaint to Local Authorities. During spreading, odours can be detected from between 1000 to 3000 metres (in exceptional weather conditions) from the field. Several factors affect the amount of odour emitted during and after slurry or manure spreading, these include:

- method of storage;
- length of storage;
- pre-treatment method employed (if any);
- type of spreading equipment used;
- rate of application to land;
- weather;
- whether the material contains waste milk or silage effluent (increases the amount of odour released).

Section 2.3 requires that where spreading takes place on the Operators own land, it is done in accordance with an approved Manure Management Plan.

Odour levels arising from different spreading techniques can vary with spreading method and burial technique. The data shows that while there will be high residual odour following application with low trajectory splash plate spreaders, the residual levels will be lower with band spreaders than with 'conventional spreaders'. Low spreading trajectory is defined as equipment operated at low pressure to create large droplets. Burial or injection of manure/slurry achieves a substantial reduction in odour emission, but may be restricted by soil and cropping limitations.

Problem	Actions to prevent or minimise odour
<p>Method of spreading</p>	<p>Splash plate spreaders</p> <p>The production of small droplets maximises the release of the volatile compounds in slurry into the air. The odour concentration during spreading can therefore be many times higher than immediately afterwards. The larger the droplets and the lower the trajectory, the lower the release of odour. It is preferable not to use splash plate spreaders near to housing.</p> <p>Band spreaders</p> <p>These discharge slurry at ground level through a series of trailing pipes. Measurement shows an odour reduction of 55-60% when compared to conventional splash plate spreaders.</p> <p>Shallow channel application</p> <p>This uses a mechanism to make grooves 50-70mm deep in the soil, 200-300mm apart and the slurry is directed into the channel immediately behind the cutting blade. Measurement shows an odour reduction of 55-60% when compared to conventional splash plate spreaders.</p>

	<p>Shallow injection</p> <p>Slurry is applied at a depth of 50-80mm in grooves 250-300mm apart. The grooves are closed again by press wheels or discs. The amount of odour emitted is approximately 85% less than for conventional spreaders.</p> <p>Deep injection</p> <p>This applies slurry at a depth of 120-300 mm in the soil using injector tines, spaced about 500mm apart. The amount of odour emitted is about 85% less than for conventional spreaders.</p>
<p>General hygiene</p>	<p>Avoid spills</p> <p>Do not overfill tankers or spreaders. Take care not to spill slurry or manure onto roadways.</p> <p>Clean machinery</p> <p>Clean spreading machinery regularly.</p>
<p>Timing and location</p>	<ul style="list-style-type: none"> • Avoid spreading during periods of high humidity and very light winds or clear, still nights. During these meteorological conditions there is very little turbulence to disperse the odour. The best dispersion occurs on windy sunny days followed by cloudy windy nights. • When odorous or partly composted manure has to be applied to land do not spread it close to houses. Where practicable, it should be spread onto arable land and then ploughed in within 24 hours. • Unless the slurry is band spread, injected or odourless, spreading should be avoided at evenings, weekends and bank holidays, unless absolutely necessary. • Spreading should not take place at night due to potential concerns over noise and nuisance. Furthermore, if run-off were to be caused, the operator would not be in a position to see impacts on watercourses etc.

Appendix 5 Noise management at intensive livestock installations

A5.1 Background

This appendix provides guidance on noise from intensive livestock farms, the measures to minimise these noise emissions and how to deal with complaints. You should refer to Horizontal Guidance for noise (H3) for details on noise pollution, noise assessment, noise management plans and the complaints procedure.

You should use this guidance if:

- there are sensitive receptors (neighbours) located within 400m of the installation; and/or
- the installation has a history of substantiated noise-related complaints within the last 3 years; and/or
- you are in the process of planning for a new installation, or extending an existing one – this guidance will provide information on best practice and impact assessment requirements.

Sensitive receptors are primarily people in houses, hospitals, schools and commercial premises, but can include people frequenting open spaces, for example, parkland. The person in control of the installation would not normally be considered to be a sensitive receptor. Persons who live in close proximity in tied housing may be sensitive receptors (consider the families of the farm workers). If such properties are rented to people who do not work on the installation, the tenants are likely to be sensitive receptors, even if they rent with the knowledge that there is a noise source nearby. Sometimes habitats, such as Special Protection Areas, may be considered as sensitive receptors, in which case detailed advice should be sought from the Agency Officer

In any particular situation however, the interpretation of the courts will be the decisive factor.

The Regulations do NOT relate to occupational exposure to noise – only to noise as an environmental pollutant, i.e. beyond the installation boundary. The Regulations also treat vibration as a pollutant, but if there is a vibration problem specialist advice should be sought and discussions held with the Agency Officer.

We have used the following time definitions in this guidance:

Day time	0700 - 2300
Night time	2300 - 0700
Working week	Monday to Friday and Saturday morning but exclusive of public and bank holidays

A5.2 Management of noise

A5.2.1 General aspects of noise management

A5.2.1.1 Overview

This section gives an overview of some of the principles of good practice for noise reduction and control. You will need to pick out those elements which most closely match your circumstances and add in any other sources or problems. Many of the solutions to address noise will also help control other emissions from the installation. You must take care to ensure

that there is no conflict with guidance designed to protect animal health and welfare, health and safety, prevent water pollution or other impacts on the local environment.

Many noise problems can be prevented by good management, consideration and ensuring a good standard of maintenance of plant and equipment. The hierarchy for control is to:

1. **Prevent** generation of noise at source by good design and maintenance.
2. **Minimise or contain noise at source** by observing good operational techniques and management practice.
3. **Increase the distance** between the source and receiver.
4. **Use physical barriers or enclosures** to prevent transmission to sensitive receptors.
5. **Sympathetic timing and control** of unavoidably noisy operations.

It is not only the level of noise that can cause annoyance, but sometimes the source itself or the time of day or night, as illustrated in the examples below:

- feed deliveries;
- animal noises such as pigs squealing;
- the time the noise occurs (noise is often more annoying at night or during leisure times);
- clattering or banging;
- tonal noise, with distinctive notes, hums or whines from vacuum pumps, fans, motors etc.;
- noise that is perceived as unnecessary.

A5.2.1.2 Prevention and minimisation

Good design and management can prevent the generation of noise. This can include:

- selection of plant and equipment that produce less noise;
- suitable timing of noisy operations;
- appropriate siting of noisy operations and noise sources at the design stage.

It is far easier to deal with potential noise problems at the design stage of a new installation or an extension or alteration to an existing one. When new equipment is purchased it is often more effective to purchase quieter equipment, that is slightly more expensive, rather than have to modify it at a later date. Many manufacturers now provide detailed noise information on their products.

A5.2.1.3 Increase the distance between the source and receiver

Care should be taken to site noisy activities away from noise-sensitive areas. The day to day location of equipment and vehicles on the installation and the way in which they are used can play a major part in reducing noise levels. Some noise sources are directional, such as fans or engine exhausts, and simply turning the noisy aspect away from the sensitive receptors can noticeably reduce the noise levels.

A5.2.1.4 Acoustic barriers

The following are examples of good acoustic barriers:

- buildings on site;

- earth banks;
- heavy and solid close boarded wooden fencing, masonry walls;
- straw bales can provide good temporary noise barriers provided there is no fire risk.

All barriers should be high enough to break the line of sight and extend beyond the noise source so that the noise does not “wrap” around the ends and top of the barrier. Vegetation barriers (trees and hedges) are often thought to provide a degree of noise reduction if planted between the source and local dwellings. However in practical terms the reduction is marginal and barely noticeable, if at all, unless the planting is very thick and many tens of metres wide. The psychological effect of removing the noise source from view probably has a much greater overall effect on the perception of the noise rather than the actual noise reduction offered.

A5.2.2 Noise management in intensive livestock installations

In many cases restricting noisy operations to reasonable times may be sufficient to overcome environmental noise problems. Reasonable times are generally considered to be the normal working day (see section A5.1.6), but it is understood that certain activities may have to be undertaken outside the normal working day, in which case additional measures may be required in order to achieve a satisfactory noise climate. The noise emitted by activities such as feed milling can be reduced considerably by enclosure within insulated buildings. It should be remembered however that the effectiveness of any form of building or enclosure as a means of reducing noise can be severely compromised by leaving doors, windows or unguarded vents open.

A5.2.2.1 Good operational practices to reduce noise

Problem	Actions to prevent or minimise noise
Feed, fuel and other deliveries	<p>Location</p> <p>Feed bins should be located so that, as far as possible, delivery movements and handling on site are reduced. Their location should not be in conflict with biosecurity arrangements.</p> <p>Delivery and collection points for feed, fuel, other materials, livestock, slurry and other waste should be sited, as far as is practicable, to benefit from the noise screening effects of local barriers, such as the lie of the land and buildings, to achieve optimum benefit.</p> <p>Operation</p> <p>Staff, contractors and visitors should be instructed not to raise voices or play radios unnecessarily at night. Pagers or mobile phones may need to be considered for on site communications.</p> <p>Hard materials should be lowered on to hard surfaces rather than dropped. The drop height of any bulk material should be reduced as much as possible.</p> <p>Timing of operations</p> <p>Delivery and collection of feed, fuel, other materials, livestock, slurry and other wastes should take place at reasonable times, i.e. during the normal working day, as far as is practicable. Drivers should</p>

	<p>comply with any speed limits on site and avoid taking empty vehicles over rough ground wherever possible.</p>
<p>Ventilation fans</p>	<p>Design</p> <p>Efficient design of ventilation fans will minimise the number needed per building.</p> <p>The use of sheet metal or other similar materials of construction, which may vibrate, should be avoided, where practicable.</p> <p>Use fewer, larger fans operating at lower speeds or variable speed fans that may produce less noise than smaller high speed fans. N.B. Although this is an effective means of noise control, variable speed fans are less effective at odour dispersion so a balance needs to be achieved.</p> <p>Minimising the resistance at the inflow and outflow to avoid placing unnecessary loading on each fan. Fan outlet cowls and stacks can provide noise reduction but, if too small, can increase the pressure drop by restricting airflow.</p> <p>Location</p> <p>Orientate noisy equipment in one direction so that noise is directed away from noise-sensitive areas.</p> <p>Locate fans at low level, i.e. on sidewalls, rather than at rooftop level as any noise emitted will be more readily blocked by other buildings, local topography etc. N.B. Although this is an effective means of noise control, variable speed fans are much less effective at odour dispersion so a balance needs to be achieved.</p> <p>Use acoustic barriers to absorb the noise.</p> <p>Operation</p> <p>The use of inlet silencers may be suitable for fan pressurised ventilation systems.</p> <p>Increase the absorption capacity of a building by increasing the presence of rough surfaces such as straw bales inside to absorb sound.</p> <p>Timing of operations</p> <p>Poultry – a small number of fans operating continuously is preferable to a larger number, switching off and on, particularly at night. However, a number of fans running continuously may not give the correct minimum ventilation required by the operator.</p> <p>Inspection and maintenance</p> <p>Fans should be maintained and inspected in accordance with the manufacturers or suppliers instructions. Out of balance or worn fans can produce high noise levels with annoying frequencies or tones.</p> <p>ACNV (Automatically Controlled Natural Ventilation)</p> <p>ACNV is an alternative method of ventilation but its use may be restricted by welfare or production factors and may be less effective</p>

	<p>at odour dispersion, so a balance needs to be achieved. Its effectiveness can be affected by its location, in particular being sheltered by other buildings, hedges etc. such that it is not always a viable alternative to fan-assisted ventilation.</p>
<p>Vehicles and machinery on site</p>	<p>You must comply with Health and Safety requirements when considering how to reduce noise from vehicles and machinery.</p> <p>Design</p> <p>Reduce the need for scraping by minimising the area of yard contaminated when removing manure and litter from buildings.</p> <p>Pressure washers and compressors may need to be placed inside buildings, purpose built or proprietary acoustic enclosures during use. Always consult with the manufacturer or supplier before enclosing any plant since suitable ventilation may be required to prevent overheating.</p> <p>Location</p> <p>Noisy machinery and operations should be sited as far as possible from noise sensitive areas.</p> <p>Loading/offloading points can be screened by the use of natural barriers (buildings, fences) or temporary screens such as straw bales.</p> <p>Generators should be placed within an acoustic enclosure or sited behind an acoustic barrier. Suitable insulation can be provided as part of a packaged generator set or by the use of an acoustically insulated building. Consideration should be given to the frequency of use, the level of risk involved and the cost implication.</p> <p>Operation</p> <p>Care should be taken to prevent unnecessary movements of trailers and loaders.</p> <p>Avoid idling of machines between work periods and revving of engines.</p> <p>Catching should be organised to minimise manoeuvring of forklift trucks etc. outside of buildings.</p> <p>Staff, contractors and visitors should be instructed not to raise voices or play radios unnecessarily at night. Pagers or mobile phones may need to be considered for on site communications.</p> <p>Timing of operations</p> <p>If powered equipment is used, cleaning out and removal of manure and litter should take place at reasonable times, where practicable.</p> <p>Inspection and maintenance</p> <p>Site roads/tracks should be maintained in a state of good repair to reduce any noise from the passage of vehicles.</p> <p>Ensure loaders and tractors etc. are well maintained especially exhaust systems and silencers.</p>

	<p>Reduce noise caused by vibrating machinery with rotating parts by proper servicing, balancing and regular maintenance. Lack of maintenance may lead to overheating, resulting in engine covers having to be left open.</p> <p>Reduce noise caused by friction in conveyor rollers, trolleys and other machines by proper lubrication and regular maintenance.</p> <p>Testing of emergency generators and alarms should be carried out during the daytime of the normal working week and preferably between 0900 and 1700. The noise level emitted by the alarms must not exceed that required to alert persons working within the site. However, to ensure the response given by call centres is 100%, alarms may also be tested at weekends. The disturbance caused by their testing can be minimised by testing at the same time and day of the week or month etc. If there are problems local residents should be consulted and timings of testing discussed with them. Testing should be in accordance with manufacturer or supplier instructions.</p>
<p>Feeding equipment</p>	<p>Design</p> <p>Auger systems are usually the quietest and most energy efficient method of transporting feed mechanically.</p> <p>Operation</p> <p>Conveyors or augers should not normally be operated when they are empty.</p> <p>Pipe and/or conveyor runs should be kept as short as possible.</p> <p>Pneumatic transfer systems can be a source of high frequency noise. It is often preferable to use a higher capacity system running at a lower speed than to use a low capacity system at high speed.</p> <p>Timing of operations</p> <p>Feed mills should be operated at reasonable times. Operate hammer mills and pneumatic conveyors when background noises are highest to minimise effect.</p> <p>Inspection and maintenance</p> <p>Maintain equipment to ensure equipment is operating to optimum standards.</p>
<p>Manure and slurry handling</p>	<p>Design</p> <p>External runs should be constructed so that they are protected from the weather and to prevent noise generation.</p> <p>Pneumatic conveyor systems should be designed to minimise the length of the run and number of bends.</p> <p>Location</p> <p>Conveyors for manure should be contained within a suitably constructed enclosure appropriately designed to reduce noise emissions.</p>

	<p>Timing of operations</p> <p>Operate equipment and vehicles at reasonable times, whenever possible.</p> <p>Inspection and maintenance</p> <p>Maintain equipment to ensure equipment is operating to optimum standards.</p>
Animal noise	<p>Feeding pigs</p> <p>Use passive feeding techniques where appropriate, to minimise squealing in anticipation of feeding.</p> <p>Reduce noise produced in response to a stimulus prior to feeding by direct delivery of feed.</p> <p>Stocking and destocking between cycles</p> <p>The timing and methods used in stocking and destocking of animals should be carefully considered to minimise any noise produced.</p>

Appendix 6 How to produce a manure management plan

A6.1 Background

Livestock manure: Includes solid manure, slurry and litter

Organic manure: Includes livestock manure and any other organic manure, such as sewage sludge and industrial waste.

Livestock manures and other organic manures are potentially valuable sources of plant nutrients, but may also cause pollution. A manure management plan will enable you to demonstrate that the best use is being made of organic manures and that pollution risks are being minimised. Contingency planning is also an important part of manure management planning, which is not currently included in other guidance.

This guidance will help you to produce an acceptable manure management plan that identifies:

- the type, volume and nutrient value of organic manure you produce and or intend to spread on your own land;
- the periods of the year when you produce organic manure;
- the amount of land you need to spread your organic manure;
- the amount of land that is available for spreading, allowing for cropping;
- the amount of storage capacity you require to prevent organic manure being spread when it's not safe to do so (i.e. to prevent the pollution of ground and surface water); and to ensure you are making the best use of the available nutrients in the organic manures you spread (e.g. nitrogen, phosphorus and potassium) taking account of nutrients already in the soil and the crop nutrient requirement.

The plan must consist of a map defining areas where organic manures:

- must never be spread (no spreading areas);
- must not be spread when certain conditions apply (very high risk areas);
- can be spread, subject to a restriction on the amount that can be applied at any one time (high risk areas);
- can be spread for most of the year with care (lower risk areas).

The reasons behind the risk classification, and the precautions that must be taken, must be clearly recorded for future reference.

The plan must include a calculation demonstrating that the amount of 'total nitrogen' in organic manures applied is less than 250 kg/ha/yr, or, if the land is in a Nitrate Vulnerable Zone (NVZ), is in accordance with the whole farm limit (livestock manures) and individual field limit (organic manures) for nitrogen as prescribed in the Nitrate Pollution Prevention Regulations.

The plan must also include:

- a description of your storage facilities and the distribution/spreading system(s) you intend to use to spread organic manures;

- a contingency plan, detailing how you will deal with emergencies such as breakdown and periods of excess rainfall.

The [Code of Good Agricultural Practice](#) (from which many figures/allowances are taken) describes more about the background to producing a plan.

A6.2 The steps to producing a manure management plan

The process of producing a manure management plan is divided into the following nine steps:

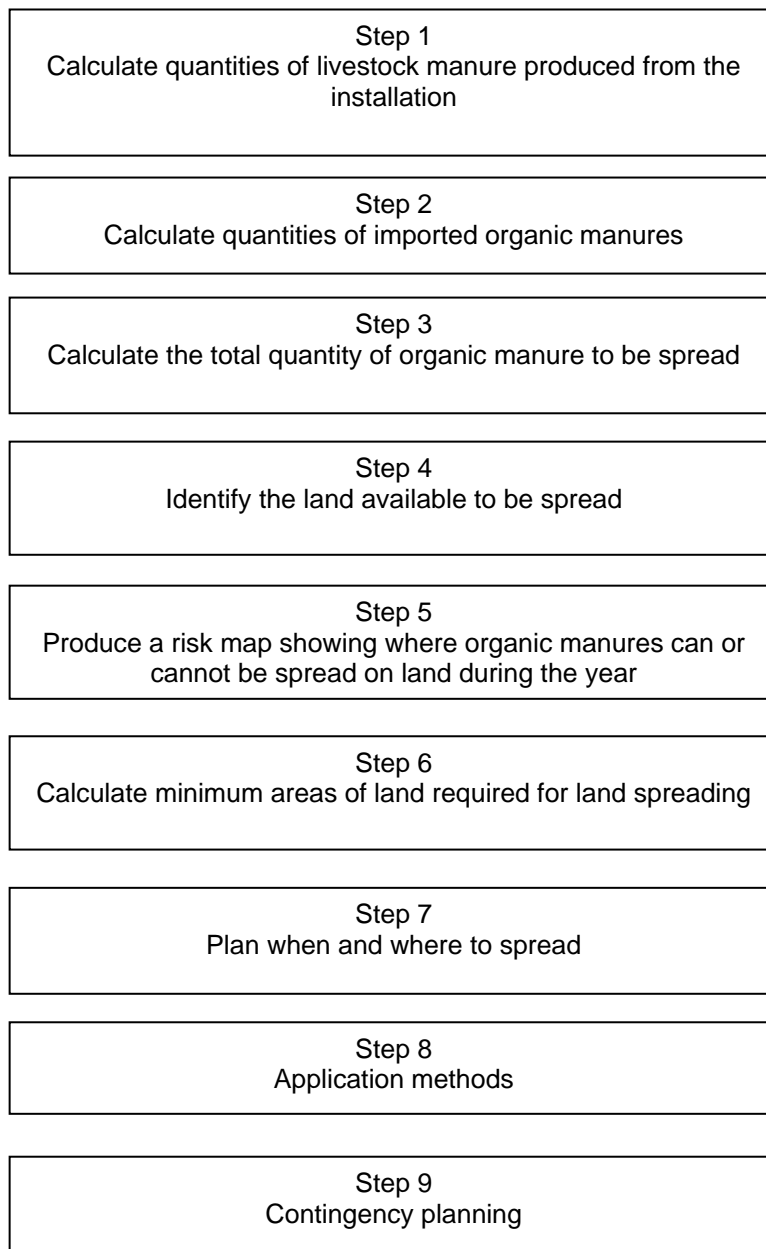

A6.3 Draw up the plan

Step 1 - Calculate the quantities of livestock manure produced from the installation

Calculate the volume of livestock manure that will be produced by the installation in one year and its nutrient value.

For existing installations some quantities, such as straw used, will be known and manure production is known or can be accurately estimated. N, P and K values for manure and slurry will be available from the analysis required under section 2.3 of this document.

For new units standard values may be used in the first plan as operating data will not be available. Quantities of slurry produced may differ from the guidelines if the dry matter percentage of the slurry is significantly less than the average (3 to 4% DM).

The volume of 'dirty water' (run-off from contaminated yard areas, effluent from housing or storage and wash water) that will be produced in a year must also be calculated together with estimated, or measured, values for its N, P and K content.

Guidance on calculating the quantities of organic manure produced, together with the quantities of bedding and of cleaning water used is given below:

Calculating manure and slurry production

A – calculate total volume of excreta produced by livestock

Measured production figures can be used, or be taken from Table A6.1 below. You should take account of the number of livestock on the unit, and the number of days the animals are housed to give the total volume produced per year.

If the slurry/manure store is not emptied every year, the base volume should be taken into account to prevent application rates being higher than anticipated.

Table A6.1 Typical volumes of excreta produced

Livestock Unit	Body Weight (kg)	Moisture Content (%)	Typical Volume (Litres/d)
1 Sow and litter (average for cycle)	130 – 225	94	10.9
1 Weaner	7 – 18	90	1.3
1 Grower	18 – 35	90	2 – 7
1 Light cutter (dry meal)	35 – 85	90	4.1
1 Baconer (dry meal)	35 – 105	90	4.5
1 Baconer (liquid feed)	35 – 105	94	7.2
1000 Laying hens	2200	70	115
1000 Laying hens (air dried)	2200	30	49
1000 Broilers and litter	2500	40	60
1000 Male turkeys and litter	13500	40	159
1000 Female turkeys and litter	6500	40	74
1000 Ducks*	3400	75	290

Figures for ducks have been obtained from 'Guidelines for Farmers in NVZs' and 'Fertiliser Recommendations for Agricultural and Horticultural Crops' (RB209)

For planning purposes one cubic metre of excreta can be taken to weigh one tonne, so figures in litres for excreta can be taken to represent weight in kilograms.

B – calculate total volume of bedding material used

Measured production figures can be used, or be taken from Table A6.2 below.

Table A6.2 Typical volumes of bedding material used

Livestock	Housing system	Litter used	Typical amount used per place per year (kg)
Pigs	Pens	Straw	102
Poultry	Deep Litter	Woodshavings or chopped straw	1.0
Broilers	Deep Litter	Woodshavings, chopped straw or paper	0.5 per bird per crop

C – calculate the volume of cleaning water used

Measured production figures can be used, or be taken from Table A6.3 below.

Table A6.3 Typical volumes of cleaning water (source 'Waterwise on the Farm' version 2)

Livestock type	Production cycle (weeks)	Wash water (Litres/day/animal)
Pigs		
Dry sows and gilts	52	0.09
Boars	52	0.09
Farrowing sows	5	5.63
Maiden gilts	10	0.09
Barren sows	10	0.09
Weaners (<20kg)	4	0.29
Growers (<50kg)	5	0.37
Finishing pigs	11	0.23
Poultry		
Pullets	16	5
Broilers	7	5
Laying hens	56	6
Broiler and layer breeders and cocks	44	5
Ducks	7	5
Turkeys (m)	20	5
Turkeys (f)	16	5

D – calculate the volume of rainfall to be disposed of

You should measure all areas draining to the slurry/manure store/system, including:

- any roof water not completely separated to the 'clean' drainage system;
- any contaminated yard water;
- any water draining off adjacent land;
- areas where livestock have regular access to food;

- areas around feed storage and disposal systems;
- areas where leakage from hoses enter the system.

You should measure the area of the storage system itself, unless the store is covered and rainwater separated to the 'clean' system.

This total calculated area should be multiplied by the rainfall onto that area to give the total volume of contaminated rainfall. Rainfall should be calculated on a minimum of a 5 year return basis (M5) and a 4 month period (1st Nov to 28 Feb) (*as a guide the M5 for this period is generally 45% - 50% of the long-term annual rainfall*).

Total volume produced by the installation = A + B + C + D
--

The default storage requirement is a minimum of 4 months storage, unless it can be shown, by a field risk assessment (Step 5), that you have safe land available during the winter months to land-spread some of your organic manure. Conversely, more than 4 months storage may be required depending on soil and site conditions. If the land is within an NVZ you must also comply with the minimum storage requirement set out in the NVZ Regulations. The amount of storage needed will also be influenced by cropping and grazing.

Step 2 - Calculate quantities of imported organic manures

You must include any other material imported on to the farm for land spreading such as:

- other livestock manure;
- sewage sludge;
- waste feed stuffs;
- all other organic materials brought on to the farm for use as a fertiliser or soil conditioner.

Step 3 - Calculate the total quantity of organic manure to be spread

Calculate the total livestock manure and other organic manure that will be spread under this plan, considering both nutrients and volume.

Total volume = (excreta + bedding + wash water + drainage from contaminated yard areas from the installation and rain directly into stores) + Other imported material
--

Step 4 - Identify the land available to be spread

Produce a map clearly showing the boundary of the land available to be spread, along with the following features:

- fields that are drained, and the location of drains if spreading is proposed on these fields;
- marsh-land and other permanently wet areas;
- ALL watercourses;
- ALL wells, boreholes and springs – including those used by neighbours, water companies etc.;
- location of effluent pipelines and hydrants;

- location of water mains;
- location of very steeply sloping land, with direction of slope.

The map should be based on Ordnance Survey (OS) data. It should show each field's OS grid reference, the field's name (e.g. Banks) or both. Whichever method you choose each field must be clearly identified on the map.

Next produce a table with a column (A) for fields that can be spread, a column (B) to record the total area of each field (in hectares), a column (C) to record the area of each field that must not be spread (Step 5) and a column (D) for the actual field area available to spread organic manures (column B minus column C).

Adding the totals given in column D will give you the total land available to be spread.

For example:

Column A	Column B	Column C	Column D
Field name or number	Total field area (ha)	Non-spreading area (ha)	B minus A (ha)
Banks	20	2	18
Crows	10	0.5	8.5
Totals	30	2.5	27.5

Non-spreading areas along ditches and watercourse can be calculated by multiplying their total length by 10,000, which will give you the area in hectares. Remember ditches and watercourses have two sides.

Step 5 - Produce a risk map showing where organic manure can or cannot be spread on the land during the year

Areas where organic manure must never be spread (A) should be coloured in red on the map (e.g. land 10 metres either side of a watercourse).

Areas where organic manure can be spread (B) need to be colour coded according to the level of risk. These are:

- orange – very high risk areas
- yellow – high risk areas
- green – lower risk areas

Areas where organic manure would not be spread (C) should be left white.

It is also advisable to include other relevant information such as:

- the reasons why land is denoted non-spreading, very high risk or high risk;
- the angle and direction of all sloping land;
- location of any soil assessments or soil monitoring points.

A) Areas where organic manure must never be spread

The following land areas, where organic manures must not be spread, should be coloured red on the map:

- areas within 10 metres of either side of any watercourse, which include ditches and piped ditches (don't forget those on the boundary of the farm);
- areas within 50 m of any spring or well;

- areas within 50 m of any borehole or reservoir that supplies water for human consumption or farm dairy use;
- areas of very steeply sloping land⁴ (>12 degrees) where runoff is likely throughout the year;
- any areas included in a tenancy agreement abatement notice due to odour problems;
- set-aside land (under discussion);
- SSSIs, ESAs or other protected areas, wetland areas;
- Groundwater Protection Zone 1, unless justified by a properly qualified person through a risk-based assessment.

Identifying, and not using, these non-spreading areas will reduce the risk of runoff reaching a watercourse, spring etc. Be aware that in some cases bigger areas will be needed, particularly up slope of a spring or shallow well. If in doubt seek advice from the Environment Agency.

B) Areas where organic waste can be spread need to be colour coded according to the level of risk

Very high risk

The following land areas should be coloured orange on the map:

- areas that have been pipe or mole drained in the last 12 months;
- areas that have been subsoiled over a pipe or mole drainage system in the last twelve months;
- areas that are pipe or mole drained and the soil is cracked down to the drains or backfill;
- areas where the soil depth over fissured rock is less than 30 cm and the soil is cracked;
- areas next to a watercourse, spring or borehole, where the surface is severely compacted¹;
- areas next to a watercourse, spring or borehole that are waterlogged;
- areas next to a watercourse, spring or borehole that have a steep slope⁴ (8-11 degrees) and the soil is at field capacity²;
- areas next to a watercourse, spring or borehole that have a moderate slope⁴ (4-7 degrees), a slowly permeable³ soil and the soil is at field capacity²;
- areas that are likely to flood at sometime in most winters.

High risk

The following land areas should be coloured yellow on the map:

- areas that have been pipe or mole drained more than 12 months ago;
- areas where soil depth over fissured rock, (e.g. limestone, chalk, slates and shales) is less than 30 cm;
- areas next to a watercourse, spring or borehole that have a moderate slope⁴ and the soil is at field capacity²;
- areas next to a watercourse, spring or borehole with a slowly permeable³ soil and the soil is at field capacity².

On high risk land you should not apply more than 50m³/ha (4500 gallons/acre) of slurry or 50 tonnes/ha of manure at one time. A gap of at least 3 weeks between each application should be left to stop the surface sealing and to let the soil recover.

Lower risk

Land available for spreading organic manures that does not fall into the preceding risk categories, and where the risk of causing pollution from spreading are low, should be coloured green.

On lower risk land it may be possible to spread manure safely at rates in excess of 50m³/ha under favourable soil and site conditions. However, an assessment will still be required to determine an appropriate application rate ceiling to prevent pollution.

C) Areas where it is not practical to spread manures

Areas where it is not practical to spread organic manures should be left white on the map, these include:

- non-farming areas such as building/roads/tracks;
- particular land use such as orchards/woodlands;
- land located too far from manure stores;
- areas where the surface is rocky, or so uneven or steep that equipment cannot be used effectively or safely.

D) Storage Requirement

The volume of storage required (Step 1), for slurry and dirty water produced, will be influenced by the field risk assessment and cropping. You must have enough storage to comply with the restrictions on land spreading identified by the field risk assessment and/or other legal requirements (e.g. NVZs). If you are unsure on how the storage requirement relates to your risk assessment and cropping seek properly qualified advice.

If you import other organic manure for land spreading (e.g. sewage sludge or industrial wastes) it must not compromise the safe storage and spreading of the livestock manures from your installation.

Manure must also be stored correctly as described in section 3.2 of this document.

Notes

¹Severely compacted means when rain stays on the land surface after rainfall.

²Field capacity is when the soil is fully wetted and more rain would cause water loss by drainage or surface runoff.

³Slowly permeable soil includes clay soil, or one through which water passes only slowly.

⁴Slope: the risk of surface runoff increases with slope and its complexity. The slope angles inserted are those generally used to describe very steep, steep and moderately sloping land. If land has complex slopes you should base your risk assessment on the steepest slope angle.

Step 6 - Calculate minimum areas of land required for land spreading

Calculate how much land is required to comply with the 250 kg/ha limit for total nitrogen from livestock manures or other organic manures, as specified in the Code of Good Agricultural Practice for the Protection of Water, or, if the land falls within an NVZ, to comply with the

limits specified in the NVZ Regulations.

For new installations where manure analysis is not yet available guidance on the areas of land needed to comply with the 250 kg/ha limit is given below in Table A6.4.

Table A6.4 Area of land required for manure spreading by animal type

Livestock Unit	No of hectares
1 Breeding sow place, including piglets up to 4 weeks	X 0.078
1 Weaner place	X 0.012
1 Grower pig place	X 0.024
1 Light cutter pig place (35 – 85 kg)	X 0.038
1 Bacon pig place (35 – 105 kg)	X 0.042
1000 Laying hens	X 2.640
1000 Broiler places	X 1.980

Multiply the number of animals by the number of hectares to give an indication of the total number of hectares required for spreading.

Compare the land required to accept this amount of N with the land identified in Step 4 as being available.

If you do not have enough land available to meet the land's 'total' nitrogen limit, and/or to spread your livestock manure safely then you must identify another outlet for the installation's manure, otherwise you will need to consider destocking.

If the shortfall is a result of importing other livestock manure or other organic manure then you will need to consider stopping that activity.

Step 7 - Plan where to spread

Use the information gathered in Steps 3 and 6, the map produced in Steps 4 and 5, and your grazing and cropping plan to determine what spreading can take place and where, taking into account the following considerations:

Areas where no spreading should take place

Red areas - these should never be used for spreading livestock manure as it would cause water pollution, damage natural habitats or in some cases break a legal obligation.

White areas – these have been judged unsuitable for various reasons. It may be possible to spread livestock manure safely at some time in the future.

Maximum annual applications to all areas

The amount of livestock manure applied to a given area in a 12 month period should not provide more than 250 kg/ha total N (200 units/acre), or, if the land is in an NVZ, the limits set out in the NVZ Regulations.

For guidance 250kg/ha is approximately equal to a maximum of:

- 62.5m³ / ha of 4% dry matter pig slurry
- 36 t/ha (16 tons/acre) fresh pig manure
- 16 t/ha (6 tons/acre) manure from laying hens
- 8 t/ha (33 tons/acre) broiler litter

All applications of livestock manure should follow the plan, take account of soil and weather conditions, and be subject to frequent checks to ensure pollution does not occur.

Remember:

- livestock manure should never be spread on any areas which are frozen hard;
- risks can be reduced by applying manures at lower rates than those recommended above;
- do not spread when the soil is so wet tractor-drawn machinery will damage the soil;
- the maximum annual application of livestock manures also applies to land used for growing maize;
- to comply with the NVZ requirements if your land is in an NVZ.

To make maximum benefit of the nutrient value of the materials it is advisable to obtain nutrient analysis of the soil to be spread and manures, including nutrient availability, so that management may be modified to maximise benefits and minimise risk to the environment. Analysis of manure from the installation, and soils where the operator spreads on his own land, is required under section 2.3 of this document.

Such analysis is also required if material is imported onto the farm for use as a fertiliser, or soil conditioner.

To minimise risks of pollution it is strongly recommended that lower risk areas are chosen first for application, then higher, only using very high risk areas at times and in conditions identified as being suitable.

If sufficient land is not available, then material will need to be exported off site.

Using Lower Risk (Green) Areas

As long as machinery does not damage the soil, and the land is not frozen hard, these areas can be used for spreading at any time of the year (although the uptake of N will be far better if manure is applied when there is a crop need).

Providing the nutrient limit of 250 kg/N/ha is observed, and that great care is taken to ensure run off or contamination of groundwater does not occur, low dry matter slurry or diluted effluents may be applied at a rate of more than 50m³/ha at any one time.

Using High Risk (Yellow) Areas

Provided machinery does not damage the soil these areas can be used for spreading at most times of the year. If the soil is at or near field capacity the following guidance **must** be followed:

- **Do not** apply more than 50m³/ha (4500 galls/acre) of slurry or other effluent at any one time.
- **Do not** apply more than 50m³/ha by travelling irrigators at any one time.
- **Do not** apply more than 5mm/hour (¹/₅th hr) effluent with sprinklers.
- **Do** move sprinklers regularly to suit conditions. On drained soils take particular care that polluting material does not pass into a watercourse.
- **Do** leave an interval of at least 3 weeks between applications.

This applies to drained and shallow soils throughout the year.

Note that:

Applying manures at lower rates than those recommended above can reduce risks further.

Some drained fields that are high risk (yellow) in winter may crack in summer. They should not be used for spreading when in this condition.

Using Very High Risk (Orange) Areas

Do not apply to these areas in the winter or when severely compacted or in the summer if the soil is cracked over drains.

Step 8 - Application methods

The means of applying livestock manure is an important consideration in reducing pollution, especially to air. Application methods allowed under in this document minimise the risk of water pollution through the reduction in run-off, and minimise the risk of air pollution through the reduction in atomisation and volatilisation of ammonia. Methods that minimise the risk of air pollution may also help reduce odour emissions and hence complaints about the spreading activity. Further detail on this is given in the [Code of Good Agricultural Practice](#).

There should be at least 3 weeks between each application of manure.

Solid manure

Solid manure should be incorporated, by using methods such as ploughing, discing or through the use of a rotary cultivator, within 24 hours unless:

- the soils are susceptible to erosion and incorporation would increase the chances of soil erosion occurring;
- the applications are made to grassland or other established crops.

Slurry

Slurry can be applied using the following application methods:

- injector or band spreader;
- irrigation equipment operated at low pressure to create large droplets and provide a low spreading trajectory providing slurry is applied to a growing crop;
- equipment with splash plates, providing slurry is incorporated within 6 hours, and providing equipment is operated at low pressure to create large droplets (to avoid slurry atomisation or drift).

Note that:

- the [Code of Good Agricultural Practice](#) contains guidance on irrigation rates and matters to consider e.g. contingencies for rainfall, irrigation rates and soil condition;
- pipework and pumps should be inspected regularly;
- incorporation is unnecessary for wash water with less than 1% dry matter.

Use of Contractors

If contractors are used for spreading a written contract confirming the responsibilities of the contractor is required. The contractor should be fully familiar with the [Code of Good Agricultural Practice](#) and this guidance.

The plan should show that the manure would be spread in accordance with these requirements.

Step 9 - Contingency planning

The plan should include contingency arrangements for:

- very wet weather;
- compliance with the NVZ Rules;
- land that is frozen hard - when no slurries or manures should be spread;
- overcoming cropping/grazing constraints (including seasonal effluent production and management practices to overcome potential constraints);
- addressing constraints on spreading to avoid smell nuisance (during certain weather conditions);
- power/mechanical failure;
- additional safeguards if night-time pumping is proposed via a LRI system;
- store/system overflows;
- an accident arising during slurry spreading operations.

A6.4 Putting the plan together

The final manure management plan should include the information generated in steps 1 – 9. If you initially identified that there is a shortfall in land area available for spreading or in storage capacity you should provide details of your plans to modify practices and the final plan should demonstrate compliance with these criteria.

The plan should show that the organic manure would be spread in accordance with the requirements of the Water Code and this guidance.

The Environment Agency Emergency Hotline number (0800 80 70 60) should be incorporated into the report and included on the map.