

Teaching mental mathematics from level 5

Measures and mensuration in number

The Coalition Government took office on 11 May 2010. This publication was published prior to that date and may not reflect current government policy. You may choose to use these materials, however you should also consult the Department for Education website www.education.gov.uk for updated policy and resources.

Teaching mental mathematics from level 5

Measures and mensuration in number

First published in 2006

Second edition 2009

This publication was originally produced as Ref: DfES 0290-2006. This edition has been updated to ensure that references to the National Curriculum programmes of study for mathematics and the support resources available through the National Strategies are current.

Ref: 00694-2009PDF-EN-01

Disclaimer

The Department for Children, Schools and Families wishes to make it clear that the Department and its agents accept no responsibility for the actual content of any materials suggested as information sources in this publication, whether these are in the form of printed publications or on a website.

In these materials, icons, logos, software products and websites are used for contextual and practical reasons. Their use should not be interpreted as an endorsement of particular companies or their products.

The websites referred to in these materials existed at the time of going to print.

Please check all website references carefully to see if they have changed and substitute other references where appropriate.

Contents

Teaching mental mathematics from level 5: Measures and mensuration in number	3
Measures and mensuration in the context of number	3
Measures	4
Estimation	4
Rounding and continuity	4
Conversion	5
Mensuration	6
Compound measure	8
Resources	13
Find as many ways as you can	13

Teaching mental mathematics from level 5: Measures and mensuration in number

Measures and mensuration in the context of number

The topics covered in this supplement are selected from the **Measures and mensuration** section of the learning objectives on the *Framework for secondary mathematics* but link closely to the **Number** (numbers and the number system) section. The suggested activities target some aspects which pupils continue to find difficult. They will support pupils thinking by, for example, encouraging them to recall the common conversions from one metric unit to another, to use consistent units in calculations and read scales carefully and not to assume that each division represents a multiple of 10.

The activities described in this supplement build upon and develop activities suggested in *Teaching mental mathematics from level 5: Number* (DCSF ref: 00691-2009PDF-EN-01). They may be easily adapted to adjust the level of challenge and keep pupils at the edge of their thinking.

Pupils can use their understanding of place value to underpin conversions between metric units and to help solve problems, using measures. The ability to translate fluently between measure and number is an important stage in the problem-solving process. This process may begin with a problem involving measures, values of which need to be used as numbers in a calculation. The result of the calculation must then be translated back into the appropriate unit of measurement and checked against the context of the problem.

Having a mental image of the number line or a place-value chart supports pupils' understanding of the base-10 number system and so helps with the relationships between different units of metric measurement.

Mensuration problems provide useful contexts in which to develop pupils' understanding of accuracy; they also provide a purpose for making decisions about appropriate levels of accuracy. It is important for pupils to understand that many measures are continuous and that mensuration often involves rounding to a suitable degree of accuracy. They need to appreciate that the degree of accuracy of a solution is linked to the degree of accuracy of the input measures.

With experience, and through discussion, pupils will begin to ask themselves questions such as:

- What are the units of the answer and how should it be rounded?
- What is the effect of the accuracy of the input data and interim calculations on my solution?

... and ultimately deal with error bounds by asking themselves:

- What is the effect of an error or rounding in a measurement? How big is the effect on the solution?
- How does this relate to the size of the solution? What is my percentage error?

The *Framework for secondary mathematics* supplement of examples, pages 228 to 232 provides contexts in which pupils should develop mental processes in measures.

Measures

Estimation

Working with measures can provide an ideal context in which to develop pupils' skills in using and applying new knowledge from different strands of mathematics. For example, as pupils make decisions about the measures in a problem, identifying and obtaining necessary information has real meaning.

Estimation is almost entirely a mental activity. A 'point of reference' is useful as a visual or mental comparison to help in making estimates. For example, knowing and recognising your own height or the area of a football pitch can help in estimating other heights or areas. Pupils should be given opportunities to develop their own collection of 'points of reference'. With practice and experience of estimating they will refine and extend their references and improve their skills.

It is helpful to engage pupils in discussion about the size of the interval within which they are able to place an estimate and whether they have a useful point of reference. It is also helpful for pupils to consider their degree of confidence in their estimates, which will be affected by both of these factors. For example, a pupil may be able to say:

- I am 100 per cent confident that your height is between 1 m and 2 m because you are not unusually tall or small.
- I am 80 per cent confident that your height is between 1.6 m and 1.8 m because I am 1.55 m tall and you are a bit taller than I am.

In interpreting the suggested progression described below it should be recognised that estimation becomes more challenging if it is set within a context or uses units that are unfamiliar.

The *Framework for secondary mathematics* supplement of examples, pages 230 to 231, provides further examples.

Make sensible estimates of a range of measures in relation to everyday situations	length, time
	mass
	area
	capacity, volume
	rates, e.g. <i>speed</i>

Rounding and continuity

Pupils should be helped to use their experience of the continuous number line to reinforce the continuous nature of many measures (including some that are often treated as discrete, such as age). A consequence is that measurements given to the nearest whole unit, for example, may be inaccurate by up to one half of the unit in either direction. It is important to take this inaccuracy into account when commenting constructively on the results obtained from calculations using these values.

Appreciate the continuous nature of scales	
Appreciate imprecision of measurement	e.g. <i>How accurate is the area of a rectangle calculated to be 7.8 m² from lengths of 6.5 m and 1.2 m?</i>

The *Framework for secondary mathematics* supplement of examples, page 231 provides further examples.

Conversion

As pupils develop their skills beyond level 5 they should learn to use units and the symbols for units of measure systematically. It is important to consider the units that are most suitable to the context of a problem. It is also helpful to recognise that the conventions of unit notation can provide insights into the nature of the problem. For example:

- If pupils understand indices and reciprocals and can interpret fractions as division then they can see the structure of compound measures. For example, by interpreting km h^{-1} as $\text{km} \times \frac{1}{\text{h}}$ and $\text{km} \div \text{h}$, they can connect the unit notation with the idea that speed is distance divided by time. This kind of connection can help with transformation of formulae.
- Conversion between different systems of measurement is usually undertaken by using approximate equivalence. For example, in converting from miles to metres one might take 1 mile to be approximately 1500 metres. By extension, to express a speed of 20 miles/hour (mph) in metres/hour (m/h) one might mentally calculate that at a speed of 20 miles/hour roughly 30 000 m would be travelled each hour.

Many conversion calculations involve making and using approximations. The same considerations apply to accuracy and rounding, as discussed above.

Know rough metric equivalents of imperial measures in daily use	8 km is approximately 5 miles
Convert one unit to another within a metric system	Metric length, mass and capacity e.g. <i>convert 750 g to kg</i>
within a non-metric system	Metric area e.g. <i>convert 62,500 m² to hectares</i> Metric volume e.g. <i>convert 5.5 cm³ to mm³</i>
Between two systems	Time e.g. <i>approximately how many more minutes there are in January than February</i>
Understand and use compound measures	Currency e.g. <i>convert £12.67 to euros</i>
	Convert one rate to another e.g. <i>convert 30 lb per square foot to kg/m²</i>

The *Framework for secondary mathematics* supplement of examples, pages 228 to 229 provides further examples.

Mensuration

It is worth considering carefully how to deal with the formulae that are used in mensuration. Pupils are more likely to use and apply a formula with confidence if they can see how it links with the properties of the shape. This understanding may be triggered as pupils work together to deduce formulae and explain their features. In many cases the deduction will develop from knowledge of a more familiar shape. For example, pupils can extend knowledge about rectangles to derive a formula for the area of a parallelogram.

When a particular collection of formulae is established then pupils need practice in using the formulae to solve problems. There are several stages to this problem-solving process and the early and later stages are often given less attention than the central calculation.

- The early stages involve making decisions about which properties are significant and which formulae are appropriate. This is a mental stage and pupils benefit from being able to discuss the options. This can be supported by, for example, sorting and classifying questions into types.
- The later stages also involve decision-making, this time about checking the units and appropriate degrees of accuracy. Pupils should consider questions such as: 'How will the accuracy of input values affect the resulting solutions?'
- Pupils should also be encouraged to consider the links between a formula and the sort of units they might expect for the answer, and to check that they are consistent. For example, the formula $A = 2\pi r$ cannot be correct because A (area) requires square units and $2\pi r$ contains only one linear unit.

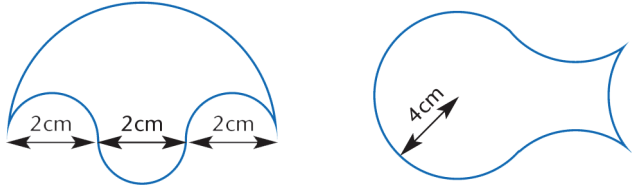
Perimeter	
rectangle, triangle, compound shapes, circle, circular arcs	

The *Framework for secondary mathematics* supplement of examples, pages 234 to 236, provides further examples.

Area

Rectangle:

compound rectangles (bits in and bits out);
 'adapted' rectangle (parallelogram,
 trapezium, right-angled triangle)

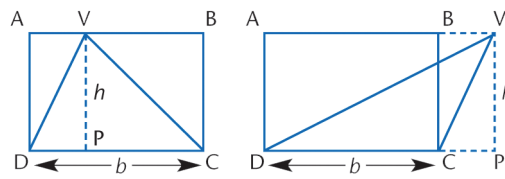

Triangle:

compound (bits in and bits out);
 'adapted' triangle (rhombus, kite, trapezium,
 parallelogram, regular hexagon)

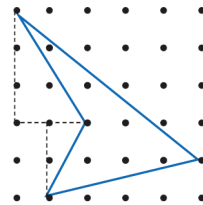

Circle:

compound (bits in and bits out);
 'adapted' circle (semicircle, quadrant,
 sector, segment)

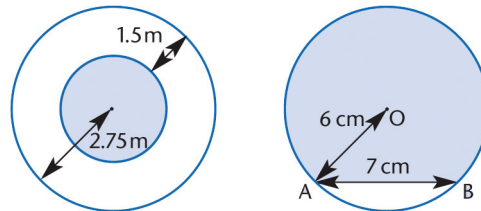

The *Framework for secondary mathematics* supplement of examples, pages 234 to 237, provides further examples.

Volume and surface area

Identify and use the measurements necessary to calculate the volume and surface area of:

cube

cuboid

right prisms including cylinder

cone and sphere

compound 3-D shapes

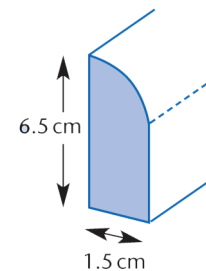
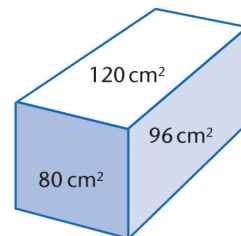
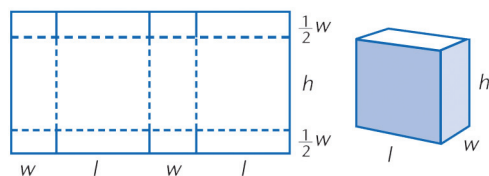

The *Framework for secondary mathematics* supplement of examples, pages 238 to 241, provides further examples.

Compound measure

The calculation stages of a problem involving compound measures can cause difficulties if pupils do not give some time to the mental stages at the start. At the outset it is important to establish a clear rationale for the units in the question and how these link together. This clarity can help to inform the various stages of any calculation and the final form of the solution. To develop this habit of mind, it can be worthwhile concentrating only on this 'entry stage' for a collection of problems. The solution may not be completed but pupils should verbalise the units and identify the link between these units and the nature of the measures in the calculation and solution. For example, they might identify the stages and associated units in working out the cost of petrol for a journey of 140 miles if the minibus averages 11 miles to the litre and petrol costs 90 pence per litre.

It is through a more thorough understanding of the connections between all the units in a mensuration problem that pupils will be better able to determine the dimension of formulae from inspecting the nature of the variables involved. This understanding will also reinforce accuracy when pupils are required to change the subject of a mensuration formula, for example, amount of petrol = rate of consumption \times distance travelled.

Understand and use compound measure, for example, speed, density or pressure to solve problems

Petrol consumption 60 litres per km

Speed of Pluto's orbit 1.06×10^4 mph

Density of gold 19.3 g/cm^3

Atmospheric pressure $1.013 \times 10^5 \text{ N/m}^2$

The *Framework for secondary mathematics* supplement of examples, page 233 and page 21, provides further examples.

Activities

Is the same as is an important way in which to interpret the meaning of the equals sign. It is used in this task, in the place of the equals sign, to compose statements linking equivalent measurements. The place-value chart is used as a visual prompt to help understand and remember the metric equivalences.

1000	2000	3000	4000	5000	6000	7000	8000	9000
100	200	300	400	500	600	700	800	900
10	20	30	40	50	60	70	80	90
1	2	3	4	5	6	7	8	9
0.1	0.2	0.3	0.4	0.5	0.6	0.7	0.8	0.9
0.01	0.02	0.03	0.04	0.05	0.06	0.07	0.08	0.09

Build on the approaches taken in *Teaching mental mathematics from level 5: Number* to illustrate the multiplicative relationships within each column of the chart by discussing the multiplication that takes you from one column entry to another. For example:

- $0.08 \times 10 = 0.8$, a step up one row
- $0.008 \times 100 = 0.8$, a step up two rows
- $80 \div 100 = 0.8$, a step down two rows.

Link the steps to the powers of ten and then link the powers of ten with the SI prefixes, for example, giga- ($\times 10^9$) mega- ($\times 10^6$), kilo- ($\times 10^3$), centi- ($\times 10^{-2}$), milli- ($\times 10^{-3}$), labelling the rows accordingly. Give the chart a heading, 'Length in metres', and say that only metres appear on the chart and that values in any row are still 10 times larger than the row below. Make explicit links between the row labels and the names given to different SI units. Ask pupils to use different SI units to give equivalences, linking the units to movement on the place-value chart by considering a column at a time and stating:

- $3000 \text{ m} = 3 \text{ m} \times 10^3$ which 'is the same as' 3 km
- $0.03 \text{ m} = 3 \text{ m} \times 10^{-2}$ which 'is the same as' 3 cm
- $0.003 \text{ m} = 3 \text{ m} \times 10^{-3}$ 'is the same as' 3 mm.

Change the chart heading to 'Mass in grams' or 'Capacity in litres' and repeat the statements appropriately for different columns.

Use the visual image, say the words together and encourage pupils to point to the movements. All of this can help them to remember the commonality of the language in the SI system and the links between the language and the powers of ten.

See also *Developing number 2* software from the ATM at www.atm.org.uk.

Fill in the missing numbers and units is an activity in which pupils complete statements on cards.

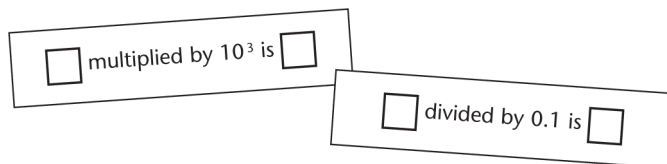

Pupils work in pairs, using a collection of cards for which they find suitable pairs of numbers. Extend this activity by asking pupils to write measurements in the blanks. Pupils could refer to A4 copies of a place-value chart annotated with SI prefixes to support the task.

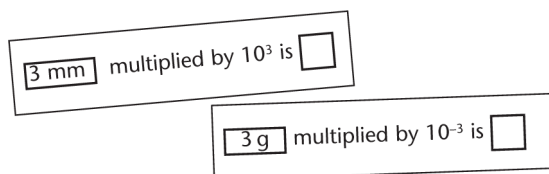

Pupils should be asked to complete similar statement cards with as many different measures as they can.

The aim is to build pupils' confidence and understanding of units of measurement. It is not about calculating.

All equivalent is a task that involves pupils in considering equivalence between different units of measurement. Give pupils two columns, one completed with increasing numbers and the other blank. Explain that the values are all equivalent measures and ask pupils, working in pairs, to complete the second column in as many ways as they can. For example, the same table could be completed in these two different ways.

All equivalent	
3000	mm
300	cm
30	
3	m
0.3	
0.03	
0.003	km

or

All equivalent	
3000	
300	
30	mm
3	cm
0.3	
0.03	m
0.003	

By explicitly focusing on the multiplicative statements linking pairs of equivalent measures, pupils will better understand the link between the base-10 number system and SI units.

Matching different forms of representation can provide pupils with the chance to confront misconceptions. For example, pupils could be asked to match cards that show the same measurement expressed in different units.

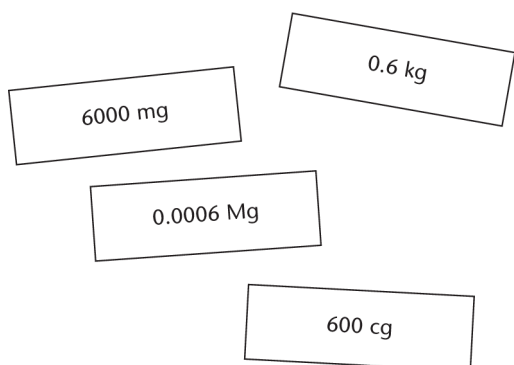

Extend the task by designing cards showing non-SI measurements such as time. Tell pupils that six of the cards are equivalent. Do not allow calculation. Cards could include examples such as:

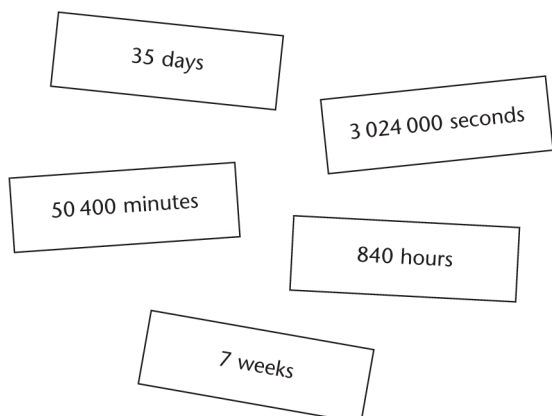

Alternatively, cards could be designed to show a mixture of measures, some in SI units and some in imperial units. Pupils could be asked to match values on cards approximately or order the cards. The activity can be further extended by asking pupils to create their own sets of cards.

Keeping the focus away from exact calculation with a calculator means that pupils are forced to work with conversion factors and approximate calculations. This helps them to 'get a feel' for the values and units.

Before or after? is a task that involves pupils in considering the differences that result from rounding before or after a calculation. Within the context of measures, calculating area, density or speed gives a purpose to decisions about the effect of various degrees of rounding before and after the calculation. Pupils, working in pairs, use a pile of cards showing four-digit measurements corrected to three decimal places, for example, 4.652 m, 2.453 m, 8.264 m, 3.894 m, 0.675 m, and 7.329 m. They each choose a card and form a multiplication calculation, such as:

$$\boxed{4.652 \text{ m}} \times \boxed{3.894 \text{ m}}$$

First, they should agree on the units for the answer and what this is showing, in this case an area in square metres (m^2). Then they estimate the size of the answer. Finally, they predict the effect of further rounding before the calculation.

- If the lengths were given in metres correct to two decimal places, would the area be smaller or larger than the result of calculating with the lengths as shown and rounding the area to two decimal places at the end of the calculation?
- Is it possible to say?

They should then test their predictions by performing the calculation both ways:

- lengths to 2 d.p., area rounded to 2 d.p.
 $4.65 \times 3.89 = 18.09 \text{ m}^2$
- lengths to 3 d.p., area rounded to 2 d.p.
 $4.652 \times 3.894 = 18.11 \text{ m}^2$

The difference is 0.02 m^2 .

There is a very important point to make here about the appropriate rounding of an answer. Working with this example can help pupils to see why they cannot be sure of the accuracy of the second place of decimals if their input measurements are only given to two decimal places.

In general, the degree of accuracy depends on the number of significant figures and, for a one-step calculation involving multiplication or division, the answer should be rounded to one fewer significant figures than specified in the least accurate 'input' measurement.

Sequencing cards could involve pupils choosing cards from a collection that shows possible excerpts from stages of a solution to a mensuration problem. Not all cards will be relevant. Examples could include:

- diagrams developed from the information in the problems;
- partially completed calculations;
- solutions rounded to different degrees of accuracy;
- units to attach to the solution.

This task will involve pupils working in pairs or small groups. Although written output may be minimal, important diagnostic feedback can be gained by listening and observing as pupils lay out their thinking. Respond to pupils' needs by adjusting follow-up tasks to challenge thinking around any area of particular concern. For example, a task could be adjusted to provide additional cards showing alternative stages at which rounding is carried out, or suggesting alternative degrees of rounding during the calculation.

For an illustration of the types of question, see the *Framework for secondary mathematics* supplement of examples, pages 233 to 241.

Find as many ways as you can to calculate a solution encourages creative thinking. It can help pupils to organise their thinking around the calculations required to solve a mensuration problem and to demonstrate that one solution is equivalent to another. Pupils can also discuss which strategy is the most efficient for each calculation, and why. Ask pupils to draw the diagram that represents their calculation. An example based on the diagram below is provided on page 13.

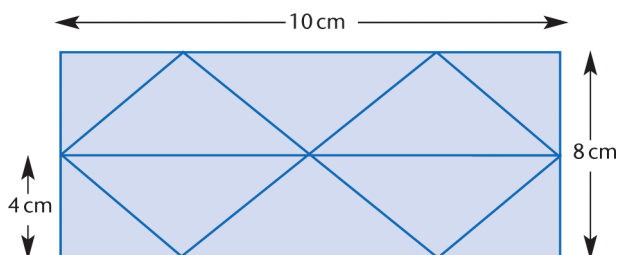

As an extension, give a different composite shape and ask pupils to make up a new set of solutions.

Annotate written solutions is an activity in which pupils compare ways of writing solutions. Provide a selection of very detailed written solutions to the same mensuration problem and ask pupils, working in pairs, to state reasons for their evaluations of the efficiency of the various strategies used. They should make suggestions for improving the efficiency and accuracy of the solution.

Analysing sets of solutions can help pupils develop their own problem-solving strategies:

- by having to explain solutions and discuss how effective they are;
- by addressing misconceptions and inappropriate methods, which they might recognise as their own.

What kind of answer? Sorting sets of cards enables pupils to identify differences and similarities between them. Give pupils some cards expressing, comparing and finding proportions and using and applying rates.

- What is the average speed for a journey of 367 miles completed in four hours?
- What is three-seventeenths of £17?
- What is 3 kg as a proportion of 23 kg?

The task is not about calculating but about identifying the nature of the solution and its units. Ask the pupils where, on a grid similar to the one below, they would place the answers to the problems posed on the cards.

number	kilograms	metres	miles per hour	£
litres	hours per machine	hours	miles	metres

Pupils could be asked to write additional questions for each cell and for any cells in the table that do not have an entry.

Resources

Find as many ways as you can

Each of the six triangles in the hexagon has the same dimensions. Calculate the total area of the hexagon.

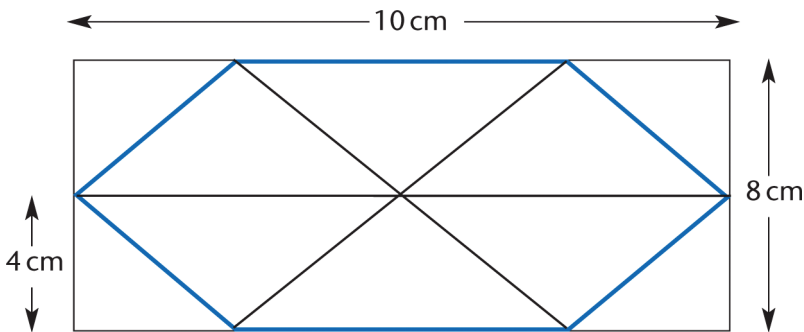

I can see six small triangles.

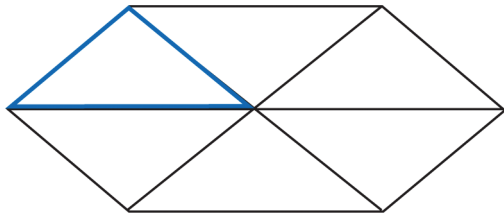

The base of each triangle is 5 cm, the height is 4 cm.

The area of a triangle is $\frac{1}{2} \times \text{base} \times \text{height}$.

Each of these triangles has an area of

$$\frac{1}{2} \times 5 \times 4 = 10 \text{ cm}^2.$$

The area of the hexagon is $6 \times 10 = 60 \text{ cm}^2$.

I can see a rectangle with four right-angled triangles that have been removed.

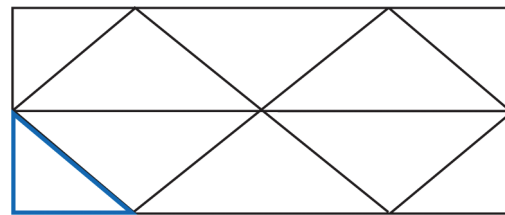

The area of the rectangle is $10 \times 8 = 80 \text{ cm}^2$.

The base of each triangle is 2.5 cm $[(10 - 5) \div 2]$ and the height is 4 cm.

The area of a triangle is $\frac{1}{2} \times \text{base} \times \text{height}$.

Each of the triangles has an area of $\frac{1}{2} \times 2.5 \times 4 = 5 \text{ cm}^2$.

The area of the hexagon is $80 - 20 = 60 \text{ cm}^2$.

I can see two trapezia.

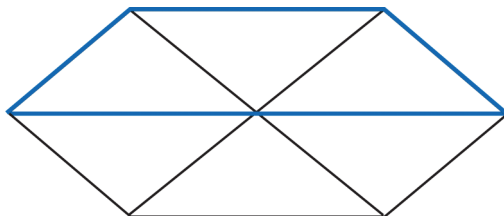

The bases of the trapezia are 5 cm and 10 cm and the height is 4 cm.

The area of a trapezium is $\frac{1}{2} \times (a + b) \times \text{height}$.

Each of these trapezia has an area of

$$\frac{1}{2} \times (5 + 10) \times 4 = 30 \text{ cm}^2.$$

The area of the hexagon is $2 \times 30 = 60 \text{ cm}^2$.

I can see 12 small right-angled triangles.

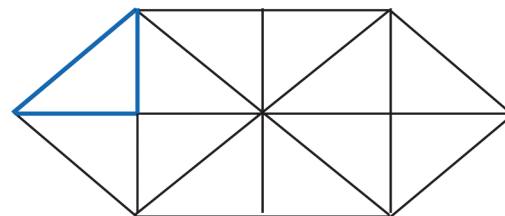

The base of each triangle is 2.5 cm, the height is 4 cm.

The area of a triangle is $\frac{1}{2} \times \text{base} \times \text{height}$.

Each of these triangles has an area of

$$\frac{1}{2} \times 2.5 \times 4 = 5 \text{ cm}^2.$$

The area of the hexagon is $12 \times 5 = 60 \text{ cm}^2$.

Audience: Mathematics teachers and consultants
Date of issue: 08-2009
Ref: **00694-2009PDF-EN-01**

Copies of this publication may be available from:
www.teachernet.gov.uk/publications

You can download this publication and obtain further information at: **www.standards.dcsf.gov.uk**

© Crown copyright 2009
Published by the Department for
Children, Schools and Families

Extracts from this document may be reproduced for non-commercial research, education or training purposes on the condition that the source is acknowledged as Crown copyright, the publication title is specified, it is reproduced accurately and not used in a misleading context.

The permission to reproduce Crown copyright protected material does not extend to any material in this publication which is identified as being the copyright of a third party.

For any other use please contact
licensing@opsi.gov.uk
www.opsi.gov.uk/click-use/index.htm



department for
children, schools and families



When you have finished with
this publication please recycle it